

PLEASE THINK BEFORE YOU PRINT



SMART Response™ PE

User's Guide

Extraordinary made simple™

SMART™

Product registration

If you register your SMART product, we'll notify you of new features and software upgrades.

Register online at www.smarttech.com/registration.

Keep the following information available in case you need to contact SMART Technical Support.

Serial number: _____

Date of purchase: _____

Trademark notice

SMART Response, SMART Notebook, SMART Notebook SE, SMART Board, SMART Sync, Senteo, the SMART logo and smarttech are trademarks or registered trademarks of SMART Technologies ULC in the U.S. and/or other countries. Microsoft, Windows, Windows Vista, Internet Explorer, DirectX, PowerPoint and Excel are either registered trademarks or trademarks of Microsoft Corporation in the U.S. and/or other countries. Mac, Mac OS, Safari and Finder are trademarks of Apple, Inc., registered in the U.S. and other countries. Adobe, Flash and Reader are either registered trademarks or trademarks of Adobe Systems Incorporated in the U.S. and/or other countries. Intel, Pentium and Itanium are trademarks or registered trademarks of Intel Corporation or its subsidiaries in the U.S. and other countries. ExamView is a registered trademark of FSCreations, Inc. All other third-party product and company names may be trademarks of their respective owners.

Copyright notice

© 2007–2010 SMART Technologies ULC. All rights reserved. The use and copying of SMART Response assessment software is subject to a license agreement. Any other use is prohibited. No part of this publication may be reproduced, transmitted, transcribed, stored in a retrieval system or translated into any language in any form by any means without the prior written consent of SMART Technologies ULC. Information in this manual is subject to change without notice and does not represent a commitment on the part of SMART.

Patent No. US6320597; US6326954; US6741267; US7151533; US7499033; CA2252302; Other patents pending.

07/2010

Important information

Before you use the SMART Response™ interactive response system, please read and understand the safety warnings and precautions described in this guide. These safety warnings and precautions instruct you in the safe and correct operation of the system and its accessories so you can prevent injuries to yourself, others or damage to the equipment. You must always ensure that the SMART Response interactive response system is being used correctly.

NOTE

If you own a SMART product other than a SMART Response PE interactive response system, refer to the user's guide that came with your product for relevant warnings and maintenance instructions.

Safety information

WARNING

- Failure to follow the installation instructions that ship with the SMART product could result in personal injury or damage to the product.
- When using the SMART Response interactive response system with a SMART Board™ interactive whiteboard and projector, do not stare into the beam of light created by the projector. Instruct children not to look in the direction of, or stare at, this beam of light.
- Ensure that any cables extending across the floor to your SMART product are properly bundled and marked to prevent a trip hazard.
- To reduce the risk of fire or electric shock, do not expose the components to rain or moisture.

IMPORTANT INFORMATION

CAUTION

- Use only the batteries provided or equivalent replacements. Do not attempt to recharge the batteries.
- Do not install batteries with the polarity (+/-) reversed.
- Do not dispose of batteries in a fire or incinerator.

Dispose of batteries according to the laws and regulations of your region. If you do not know the applicable rules for your region, consult the battery manufacturer.

- Do not use abrasive erasers or harsh chemicals when cleaning SMART Response interactive response system hardware.
- Do not open the receiver or clicker units to attempt repairs. Refer all service to authorized SMART service personnel.

IMPORTANT

- You must connect the USB cable that came with your SMART product to a computer that has a USB compliant interface and that bears the USB logo. In addition, the USB source computer must be compliant with CSA/UL/EN 60950 and bear the CE mark and CSA and/or UL Mark(s) for CSA/UL 60950. This is for operating safety and to avoid damage to the SMART product.
- If your SMART product requires replacement parts, make sure the service technician uses replacement parts specified by SMART Technologies or parts with the same characteristics as the original.

Compliance

This device complies with Part 15 of the FCC rules. Operation is subject to the following two conditions:

1. This device may not cause harmful interference, and
2. This device must accept any interference received, including interference that may cause undesired operation.

Changes or modifications to this equipment not expressly approved by SMART Technologies may void the user's authority to operate this equipment.

IMPORTANT INFORMATION

i NOTE

This equipment has been tested and found to comply with the limits for a Class B digital device, pursuant to Part 15 of the FCC Rules. These limits are designed to provide reasonable protection against harmful interference in a residential installation.

This equipment generates, uses and can radiate radio frequency energy and, if not installed and used in accordance with the instructions, may cause harmful interference to radio communications. However, there is no guarantee that interference will not occur in a particular installation. If this equipment does cause harmful interference to radio or television reception, which can be determined by turning the equipment off and on, the user is encouraged to try to correct the interference by one or more of the following measures:

- Reorient or move the receiver or clicker units.
- Increase the separation between the equipment and the product.
- Connect the affected equipment to an outlet on a circuit different from that to which the receiver's computer is connected.
- Consult your SMART service representative or an experienced radio/TV technician for help.

Contents

Important information	i
Safety information.....	i
Compliance.....	ii
About SMART Response	1
Introduction.....	1
Features.....	2
Hardware – clickers and receivers.....	3
Installing SMART Response	5
Environmental requirements.....	5
Computer requirements.....	6
Installing SMART Response software.....	7
Connecting hardware and activating SMART Response.....	8
Selecting how students answer questions.....	13
Getting started	17
About SMART Response.....	17
Asking instant questions.....	19
Setting up Teacher Tools.....	20
Creating a class list.....	23
Editing a class list.....	28
Using SMART Response	31
About SMART Notebook.....	32
Creating assessments.....	33
Adding questions to the assessment.....	36
Starting and connecting to a class.....	48
Disconnecting students from a class.....	55
Using clickers.....	56
Completing assessments.....	62
Reviewing, printing and exporting assessment results	69
Importing assessment results.....	69
Reviewing assessment results.....	71
Flagging results.....	74
Generating student performance reports.....	75
Generating class performance reports.....	76
Printing and exporting questions and results.....	76

CONTENTS

Maintaining SMART Response	81
Preventing component damage	81
Changing clicker batteries	82
Resetting clickers	83
Receiver indicator lights	83
Troubleshooting the receiver	84
Other troubleshooting tips	85
Hardware environmental compliance	87
Waste Electrical and Electronic Equipment Regulations (WEEE directive)	87
Restriction of Certain Hazardous Substances (RoHS directive)	87
Batteries	87
Packaging	88
Covered electronic devices	88
China's Electronic Information Products regulations	88
U.S. Consumer Product Safety Improvement Act	88
California Air Resources Board – Airborne Toxic Control Measure	88
Restriction of Certain Chemicals (REACH directive)	89
Customer support	91
Online information and support	91
Training	91
Technical support	91
Shipping and repair status	91
General inquiries	92
Warranty	92
Registration	92

Chapter 1

About SMART Response

IN THIS SECTION

Introduction.....	1
Features.....	2
Hardware – clickers and receivers.....	3

Introduction

The SMART Response interactive response system is an assessment tool that enhances learning. It facilitates summative and formative assessment by enabling you to pose a question before, during or after a lesson to find out whether students are on track. You can use the feedback to help shape the rest of your lesson.

Once you finish the lesson, create a question set with SMART Response assessment software to evaluate learning more formally. You can feel confident that the students have answered the way they intended, because they can verify and change their self-paced responses directly.

Teachers can easily add creativity to questions by combining text with images to make questions more dynamic. SMART Response comes with SMART Notebook™ collaborative learning software, and offers 6,000 learning objects that you can add to quizzes.

SMART Response also increases one-to-one interaction by enabling teachers to survey and engage students and to collect responses.

CHAPTER 1

About SMART Response

Features

Feature	Description
Integration with SMART Notebook	Open SMART Response from a tab in SMART Notebook software. With SMART Notebook's Gallery of more than 6,000 items of graphic-rich content, you can add images and other multimedia content to your questions and/or assessments.
Multiple assessment options	Compile questions for formative and summative assessment, prepare quizzes or exams in advance and ask spontaneous questions to gauge student comprehension at any point during a lesson.
Teacher Tools	Access, view and manage all assessment data in one location. This powerful tool enables you to create class lists and manage tests and quizzes.
Question variety	Teachers can ask different types of questions, including true or false, yes or no, multiple choice, multiple answer, numeric fraction or math expression and text answer.
Familiar user interface	SMART Response's intuitive software lets you create pages that have clear, contextual and concise information for users at any level of experience.
Monitoring students during and after the test	You can monitor how much time is remaining for a quiz. Grades are immediately calculated after the test and displayed in graphical charts and numeric tables.
Previewing results during an assessment	You can see what responses students have submitted during the assessment and get immediate feedback on how the class is doing.
Easy-to-view results	Display results in easy-to-view pie charts or graphs, which you can then insert on a SMART Notebook page for a closer view and to add your own notes in digital ink. You can also view results in detail, so you can see exactly how each student has answered.
Add or change correct answers to completed assessments	Using Teacher Tools, you can choose to accept a submitted answer as correct in addition to (or instead of) the original correct answer. SMART Response calculates the students' grades after the changes.
Multiple print options	Print assessments as handouts so students can complete them at their own pace, or add comments to completed assessments that can be printed and used later as study guides.

CHAPTER 1

About SMART Response

Feature	Description
Anonymous mode	Allows students to respond with complete anonymity. Students can use SMART Response without signing in, or they can participate in an assessment using any clicker, allowing you to gauge the group's understanding.
Integration with third-party question bank	SMART Response is compatible with other commonly used file formats, so you can easily import questions from other applications, including Microsoft Word and PowerPoint®, PDFs and third-party question banks.
Integrated Gradebook	Through Teacher Tools Gradebook, you can build comprehensive student progress reports which can be as simple or as detailed as you need. Create high-level comparisons of class performance, specific reports based on tagged characteristics such as demographics or curriculum standards, or personalized reports on how individual students are doing.
Tagging	You can tag students and questions and automatically generate reports with comprehensive student and class performance breakdowns. You can also tag key words to describe various characteristics, correlate questions to curriculum standards and break down performance into a printable chart.

Hardware – clickers and receivers

Feature	Description
Radio frequency (RF) technology	RF technology provides a reliable wireless connection between the student clickers and the central receiver. You don't need a line of sight to the clickers, and the clickers and the receiver can connect within a 100' (30 m) range.
Ergonomic design	Designed to fit comfortably in young hands or to lie flat on a desk. Even young students find the durable handheld clickers easy to use and comfortable to hold. Responding to questions is quick and easy.
LCD screen	The easy-to-read LCD screen has room to display several lines of text. Students can see whether responses have been sent, and they can review the status of their clicker's battery power and network connection.
Descriptive icons	Icons on the LCD screen enable students to monitor the battery power and the network status of their clicker.
Extended battery life	Each clicker uses long-lasting AA batteries.
Easy connection	The receiver connects to a computer using a USB cable, and it doesn't require an additional power adapter.
Flexible installation	The receiver weighs just under 6 oz. (165 g) and easily mounts onto walls, desks or tables.

Chapter 2

Installing SMART Response

Environmental requirements.....	5
Temperature.....	5
Humidity.....	5
Water and fluid resistance.....	6
Dust and scratching.....	6
Electrostatic discharge (ESD).....	6
Conducted and radiated emissions.....	6
Computer requirements.....	6
Windows operating systems.....	6
Mac OS X operating system software.....	7
Installing SMART Response software.....	7
Connecting hardware and activating SMART Response.....	8
Connecting the receiver.....	8
Recommended height for mounting the receiver.....	8
Extending the USB cable.....	10
Checking the receiver's status.....	11
Activating SMART Response.....	11
Selecting how students answer questions.....	13

Environmental requirements

Before installing or using your SMART Response interactive response system, review the following environmental requirements and compliance statements.

Temperature

SMART Response components can operate in the temperature range of 41°F to 95°F (5°C to 35°C). In addition, the product can withstand storage temperatures from -40°F to 120°F (-40°C to 50°C).

Humidity

SMART Response components can operate in up to 80% relative humidity, non-condensing.

CHAPTER 2

Installing SMART Response

Water and fluid resistance

SMART Response components are for indoor use only and don't meet any salt-spray or water-ingress requirements. Don't pour or spray any liquids directly onto SMART Response components. These liquids can get into areas where they can damage sensitive electronic components.

Dust and scratching

SMART Response components are for use in office and classroom environments, and they aren't for industrial use where heavy dust and pollutants can cause malfunctions or impaired operation. They're designed for pollution degree 1 (P1) as per EN61558-1, which is defined as "No pollution or only dry non-conductive pollution."

Electrostatic discharge (ESD)

SMART Response components meet the requirements of EN61000-4-2 severity level 4 for direct and indirect ESD. No malfunction or damage up to 15 kV (both polarities) with a 330 ohm, 150 pF probe (air discharge). Unmated connectors meet 8 kV for direct (contact) discharge.

Conducted and radiated emissions

SMART Response hardware's narrowband radiated electric field meets the limits for Class B performance, as defined in EN55022/CISPR 22.

Computer requirements

Windows operating systems

- Pentium® III 750 MHz or later processor
- 512 MB of RAM (1 GB recommended)
- 800 MB of free hard disk space for minimum installation (2150 MB for full installation with Gallery collections)
- Windows® XP, Windows Vista® or Windows 7 operating system
- Internet Explorer® Internet browser 6.0 or later
- Adobe® Flash® 10 or later
- Adobe Reader® 8.0 or later
- Microsoft® DirectX® technology 8.1 or later (required for SMART Video Player)

CHAPTER 2

Installing SMART Response

Mac OS X operating system software

- 1 GHz PowerPC® G4 or G5 processor or Intel® processor (universal binary)
- 1 GB of RAM
- 800 MB of free hard disk space for minimum installation (2 GB for full installation with Gallery collections)
- Mac OS X 10.5.8 or 10.6.x operating system software
- Safari application program 3.0.4 or later
- Adobe Flash Player 10 or later

i NOTES

- 1 MB = 1024² bytes, 1 GB = 1024³ bytes.
- SMART Response assessment software runs on 32-bit operating systems only.
- You're unable to use SMART Response on Windows computers with Intel® Itanium® processors.

Installing SMART Response software

■ To install SMART Response software on a Windows computer

1. Insert the SMART Response DVD into your computer's drive.
If the SMART Response installation wizard doesn't appear, browse to and double-click the **CDBrowser.exe** file on the DVD.
2. Click **Install SMART Response Software** to start the wizard, and then follow the on-screen instructions.

■ To install SMART Response software on a Mac computer

1. Insert the SMART Response DVD into your computer's drive.
2. Double-click the **SMART Response DVD** icon.
3. Double-click the **CDBrowser** icon.
4. Click **SMART Response Software**, click **Continue**, and then follow the on-screen instructions.

Connecting hardware and activating SMART Response

To send information to and receive information from SMART Response clickers, you must connect the SMART Response receiver to your computer. You can then check the receiver's status in Teacher Tools.

IMPORTANT

You must activate your SMART Response software within 30 days of installation to keep it active. SMART Response software automatically activates when you connect your SMART Response receiver. If the activation isn't successful, use the manual procedure in this section to find your license code and activate the software.

Connecting the receiver

IMPORTANT

- Do not connect the receiver to your computer until after you install SMART Response software.
- For operating safety and to prevent damage to the receiver, connect its USB connector only to a computer that has a USB compliant interface and that bears the USB logo. In addition, the USB source computer must be compliant with CSA/UL/EN 60950 and bear the CE mark and CSA and/or UL mark (s) for CSA/UL 60950.
- The receiver has a USB 2.0 full-speed peripheral interface that runs at speeds of up to 12 Mbps. The unit works with USB 2.0- and USB 1.1-compliant USB interfaces.

Recommended height for mounting the receiver

Unlike infrared devices, SMART Response receivers don't require an unobstructed line-of-sight transmission path, such as that required by infrared devices. You can operate SMART Response over longer distances if you minimize interference, signal reflections and the number and size of objects between the receiver and the clickers.

Choose a location for the receiver that's as high as possible and in plain view of the students' clickers. For permanent installations, use a USB extender to mount the receiver high on a wall. To minimize interference from other radio-frequency equipment, position the receiver away from other wireless products, such as 2.4 GHz routers and cordless telephones.

CHAPTER 2

Installing SMART Response

WARNING

To prevent product damage or personal injury, route the USB cable where it will not be stepped on or tripped over.

To connect the receiver

1. Position the receiver in an unobstructed location away from other wireless products, such as 2.4 GHz routers and cordless telephones.
 - For temporary installations, place the receiver on top of your desk.
 - For permanent installations, mount the receiver on a wall or on the front of a piece of furniture using two screws (not provided).

Orient the receiver with the long side or edge facing the class as shown.

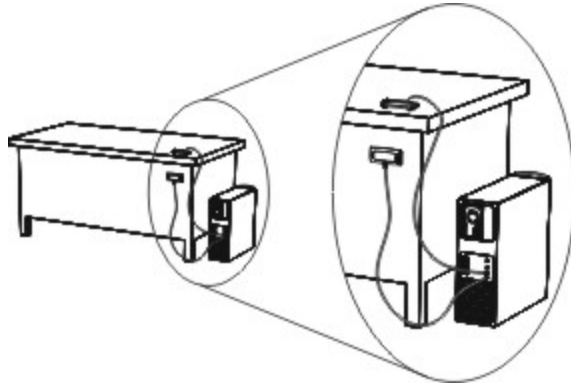

2. Insert the receiver's captive USB cable connector into an available USB receptacle on your computer.

The Ready light on the receiver turns on to indicate that the receiver is receiving power.

On Windows computers, the first time you connect the receiver, a balloon message appears from the notification area indicating that new hardware has been detected.

IMPORTANT

If the balloon message indicates that Windows is starting to try to locate a driver from the Microsoft website, stop the search. If Windows does not find the driver on your computer, you did not install SMART Response software. Install the software and repeat the above procedure.

3. See *Checking the receiver's status* on page 11 to verify that the receiver is working properly.

CHAPTER 2

Installing SMART Response

Extending the USB cable

If the provided 6' (1.8 m) USB cable attached to the receiver isn't long enough, use active USB extender cables, USB extenders or hubs.

This graphic shows the SMART active USB extension cable (Part No. USB-XT).



In some cases, you can use up to four cables to extend the length to about 80' (25 m), which is the limit of the USB specification. Passive USB extension cables aren't supported.

Alternatively, USB extenders that use Cat 5 cabling can extend the range to approximately 325' (100 m) at a much higher cost. The more economical SMART USB extender pair (Part No. CAT5-XT) can extend the USB connection up to 120' (36.6 m) on Windows computers or 90' (27.5 m) on Mac computers using an RJ45 Cat 5 cable.



These units require that you use the provided 6' (1.8 m) cables or use cables and connectors that meet the same specifications. Impedance mismatches and poor connections can cause signal degradation and performance problems.

i NOTE

Some computers use internal active hubs to provide more USB receptacles. The computer's operating system could interpret these internal hubs as external devices, limiting the number of USB extenders you can use.

Checking the receiver's status

If you connected the receiver, you're ready to start a class session. You can check the receiver's communication status at any time using the following procedure.

■ To check the receiver's status

1. Click the **SMART Response** icon  in the Windows notification area or Mac menu bar.
A message appears below the *Configure Devices* heading indicating how many receivers are connected.

2. Click the icon below the *Configure Devices* heading.

Teacher Tools starts.

The *Devices* window appears showing a status message.

3. If a "Your SMART Response receiver is connected and working" message appears, the SMART Response receiver is connected and communicating with the SMART Response software. The receiver name appears below the *Devices* button.

Click **My Receiver** to display the classroom name and the make, model and hardware ID (MAC address) of the receiver.

OR

If a "Your SMART Response receiver is not connected" message appears, the SMART Response receiver isn't connected or isn't working properly. The receiver name doesn't appear below the *Devices* button.

Check the receiver connections or repeat the receiver installation. See *Connecting the receiver* on page 8.

Activating SMART Response

You must activate your SMART Response software within 30 days of installation to keep it active. SMART Response software automatically activates when you connect your SMART Response receiver. If the activation isn't successful, use the following procedure to find your license code and activate the software.

You must connect your computer to the Internet and connect the SMART Response receiver to your computer before you can search for a license code. After you complete the following procedure to find your license code, you can use the code to activate SMART Response assessment software on other computers, as outlined in the *License* tab in the *About SMART Response* dialog box.

NOTE

After you find your license code, you don't need to connect the SMART Response receiver to the other computers that you want to activate SMART Response software on.

To find your license code and activate SMART Response software

1. Click the **SMART Response** icon  in the Windows notification area or Mac menu bar, and then select **Activate SMART Response Assessment Software**.

The *SMART Response Software Evaluation* dialog box appears and displays the time remaining in your software's evaluation period.

NOTE

If your SMART Response software is already activated, the **Activate SMART Response Assessment Software** command is replaced by **Check for Updates**.

2. Click **Activate Now**.
3. If a dialog box appears requesting a password, type an administrator's password, and then click **OK**.

NOTE

Contact your system administrator if you don't know your password.

4. Click **Find License Code**.

NOTE

You must connect your computer to the Internet and connect the SMART Response receiver to your computer before you can search for a license code.

5. Click **Find License Code**.

The license code appears. The activation program automatically copies your license code into the *License Code* box.

NOTE

If you didn't connect the receiver, a warning message appears. Click **OK** to close the dialog box.

6. Record the license code in a safe place, and then click **Close**.
7. Type your e-mail address in the *License Code* box, and then click **Next**.

Your SMART Response software activates.

CHAPTER 2

Installing SMART Response

8. Click **Finish**.

Now that you have your license code, complete the following procedure to activate SMART Response software on other computers.

■ To find the license code after the software is activated

1. Click the **SMART Response** icon  in the Windows notification area or Mac menu bar, and then select **About SMART Response**.
2. Record the license code that appears on the *Description* tab.

■ To activate SMART Response software on other computers

1. On another computer, click the **SMART Response** icon  in the Windows notification area or Mac menu bar, and then select **Activate SMART Response Assessment Software**.

The *SMART Response Software Evaluation* dialog box appears and displays the time remaining in your software evaluation period.

NOTE

You don't need to connect your SMART Response receiver during this procedure.

2. Click **Activate Now**.
3. If a dialog box appears requesting a password, type an administrator's password, and then click **OK**.
4. Type your license code and e-mail address, and then click **Next**.
5. Click **Finish**.

Your SMART Response software activates.

Selecting how students answer questions

Students can answer questions using one of these options:

- SMART Response / Senteo™ clickers
- SMART Response PE clickers
- SMART Response LE clickers
- SMART Response XE clickers
- SMART Notebook SE (Student Edition) software on student computers
- SMART Response VE using Internet enabled devices

CHAPTER 2

Installing SMART Response

Each of these devices has a corresponding mode in SMART Response. When you or your system administrator first installed SMART Response, you selected the appropriate mode for the devices in your classroom. You can change the mode after installation using the SMART Response Setup Tool. You can also operate SMART Response in Mixed mode where you can use a combination of SMART Response clicker types simultaneously.

NOTES

- If you have more than one type of SMART Response clicker in your classroom, you can choose Mixed mode, or you can choose the mode that matches the type of clicker you're using, and then use only that type of clicker while in that mode.
- Some question types aren't available for all devices. See *About question types* on page 36 for more information.
- Although you can use SMART Response LE clickers in Mixed mode, students can only answer the first question of an assessment.
- Students are unable to use SMART Notebook SE (SMART Response CE) or Internet enabled devices (SMART Response VE) while SMART Response is in Mixed mode.

To open the SMART Response Setup Tool on a Windows computer

1. Stop any running classes, and close SMART Notebook and Teacher Tools if they're running.
2. Select **Start > All Programs > SMART Technologies > SMART Response > Setup Tool**.

The *SMART Response Setup Tool* window opens.

To open the SMART Response Setup Tool on a Mac computer

1. Stop any running classes, and close SMART Notebook and Teacher Tools if they're running.
2. In the Finder, browse to **Applications/SMART Technologies/SMART Response**, and then double-click **SMART Response Setup Tool**.

The *SMART Response Setup Tool* window opens.

CHAPTER 2

Installing SMART Response

■ To select how students answer questions

1. Open the SMART Response Setup Tool.
2. Select one of the following options:
 - SMART Response / Senteo
 - SMART Response PE
 - SMART Response LE
 - SMART Response XE
 - SMART Notebook SE
 - SMART Response VE (beta)
 - Any SMART Response clicker

i NOTE

SMART Notebook SE input isn't currently available for Mac OS X operating system software.

3. Click **OK**.

A message appears stating that your setup has changed. If you switch to SMART Response VE mode, a message appears asking you to accept the terms of use.

When you start SMART Response software, your students can answer questions using the device you selected in step 2.

i NOTE

The links to the SMART Response Help change to reflect the tool you selected in step 2. For example, if you selected SMART Notebook SE, the links point to the SMART Response CE Help.

If you kept this Help open when you selected the new tool, close the Help, and then open it in the new mode.

Chapter 3

Getting started

IN THIS SECTION

About SMART Response.....	17
Teacher Tools.....	18
SMART Response hardware.....	18
Using the interactive response system.....	18
Asking instant questions.....	19
Setting up Teacher Tools.....	20
Starting Teacher Tools.....	20
Creating a SMART Teacher file.....	21
Editing your SMART Teacher file.....	22
Adjusting privacy and alert options.....	22
Using Privacy mode.....	22
Changing alerts.....	23
Creating a class list.....	23
Creating a class list in Teacher Tools.....	23
Importing a class list from Excel.....	24
Importing a class list from a CSV file.....	25
CSV file formatting.....	26
Tips for formatting CSV files for importing class lists.....	26
Editing a class list.....	28
Editing student information.....	28
Adding students to a class list.....	28
Removing students from a class list.....	29
Tagging students.....	29
Changing a class's passing grade.....	30

About SMART Response

Using the SMART Response interactive response system, you can perform planned or spontaneous student assessments in the same software you use to deliver your lessons—it integrates seamlessly with SMART Notebook collaborative learning software.

CHAPTER 3

Getting started

You can easily prepare exams in advance or spontaneously quiz students during a lesson and receive immediate responses from your class. Depending on the mode you're using, SMART Response software supports several different types of questions, including true or false, yes or no, multiple choice, multiple answer, text answers, and numerical fractions and expressions. You can import questions from third-party question banks, Microsoft applications and other common programs.

After students submit their answers, you can see the results by percentage in a graphical format giving an accurate representation of the whole class's performance, not just that of individual students.

Teacher Tools

Using Teacher Tools, you can access, view and manage all assessment data in one location. You can create class lists and set up, conduct and manage tests and quizzes. You can track each student's progress over several assessments, and you can even tag questions with key words to evaluate test results and student performance in greater detail.

Teacher Tools makes it easy for you to keep everything organized. The easy-to-use management tool automatically files test results in the built-in gradebook. It also lets you manage your class lists and view performance reports and test scores.

The Teacher Tools Gradebook gives you quick access to test results, making it easy to prepare reports and conduct evaluations. Reports can be as simple or as detailed as you need. Create high-level comparisons of class performance, specific reports based on tagged characteristics such as demographics or curriculum standards, or personalized reports on how individual students perform. You can also create reports that show grades for the entire school year.

SMART Response hardware

The SMART Response receiver and clickers use radio frequency technology to provide a reliable wireless connection between the student clickers and the central receiver. You don't need a line of sight to the clickers, and the range is 100' (30 m). The receiver verifies receipt of every signal and messages automatically re-send if they aren't received.

Students find the handheld clickers easy to use and comfortable to hold. Students can easily read several lines of text on the large display screen. They can see if responses have been sent and can review the status of their clicker's battery power and network connection.

Using the interactive response system

You can purchase SMART Response interactive response system software for both Windows and Mac computers that meet the minimum specifications. See *Computer requirements* on page 6 for information.

CHAPTER 3

Getting started

You can use SMART Response's integrated SMART Notebook features on any computer, so you can take your laptop home to develop assessment questions without having to connect a SMART Response receiver. You can then copy the assessment files to a classroom computer where you can run your assessments.

When you install SMART Response software, by default, the installation program installs SMART Notebook software, SMART Product Drivers and SMART Response software. SMART Response software includes Teacher Tools and new menus that appear in the SMART Notebook toolbar. You can use the software free of charge for 30 days after which you must activate the software.

Asking instant questions

Use the Instant Question feature to introduce the SMART Response interactive response system to your students. Instant questions are individual questions you ask spontaneously—they aren't part of an assessment. When you use the Instant Questions feature, you're unable to type a question or assign a correct answer.

You can ask an instant question verbally, write or type it on an interactive whiteboard and add objects directly onto the SMART Notebook page.

NOTE

Make sure that you start your class and that all students are connected before you ask instant questions.

To ask individual questions using the Instant Question feature

1. Click the **SMART Response** icon  in the Windows notification area or the Mac menu bar, and then select **Open Notebook Software**.

A blank SMART Notebook page appears.

2. Click **Insert Question**  on the toolbar.

TIP

If *Insert Question* isn't on the toolbar, you can right-click the toolbar and add it.

3. Click one of the **Instant Question** buttons.

The *Instant Question* dialog box appears asking whether you want to insert the question on this page or on a new page.

CHAPTER 3

Getting started

4. Select one of the options.

TIP

If you want to use the same option by default, select the **Always perform this action** option. You can change the default in the *Preferences* menu.

A SMART Notebook page appears showing the possible answers to the question. The *Response* tab changes to *Single Question*, and the *Progress* button is selected.

The question starts automatically and appears on the student's display.

NOTE

If you haven't started a class, a message appears asking you to select a class. Select a class, and then click **Start Class**.

5. Present your question to the class.
 6. After all students answer the question, click **Stop this question**.
 7. To save the results, click **Save** .
- To add another question without clearing the results of the previous question, don't click **Clear**, and then repeat steps 2 to 5.

Setting up Teacher Tools

With Teacher Tools, you can:

- check the status and performance of the receivers, clickers and students
- select the mode of operation
- manage class lists
- start classes so that students can sign in with their clickers

When you open Teacher Tools for the first time, you create a SMART Teacher file. You can later edit the SMART Teacher file and adjust the privacy options.

Starting Teacher Tools

When you start SMART Response Teacher Tools for the first time, it opens to the *Welcome to Teacher Tools* view where you can create a SMART Teacher file, manage class lists, generate class or student performance reports and perform many other tasks.

■ To start Teacher Tools

Click the **SMART Response** icon  in the Windows notification area or Mac menu bar, and then select the icon below the *Teacher Tools* heading.

Teacher Tools appears in *Gradebook* view.

NOTE

If SMART Notebook is open, you can also start Teacher Tools by selecting **Response > Teacher Tools**.

Creating a SMART Teacher file

If you want to save all of your class lists and assessment results, you need to create a SMART Teacher file. Your SMART Teacher file also enables your students to find and connect to your classes when they connect in Sign In mode.

If needed, you can create additional SMART Teacher files after you create the initial one.

■ To create a SMART Teacher file the first time you use SMART Response

1. Click the **SMART Response** icon  in the Windows notification area or Mac menu bar, and then select the icon below the *Teacher Tools* heading.

The *Welcome to Teacher Tools* wizard appears.

NOTE

The wizard appears only if you haven't created a SMART Teacher file.

2. Type your name and other information in the text boxes. The **Save** button is unavailable until you provide all the required information.

3. Click **Save**.

A *Save As* dialog box appears.

4. Type a file name, and then click **Save**.

The .teacher file saves and the *Gradebook* window appears displaying the teacher's name.

■ To create an additional SMART Teacher file

1. Start Teacher Tools. See *Starting Teacher Tools* on previous page.

Teacher Tools appears.

CHAPTER 3

Getting started

2. Select **File > New**.

The *Gradebook Information* screen appears.

3. Type your information in the text boxes, and then click **Save**.
4. Browse to where you want to save your SMART Teacher file, and then click **Save**.

Editing your SMART Teacher file

The first time you started SMART Response Teacher Tools, you created a SMART Teacher file to let your students find and connect to your class. See *Creating a SMART Teacher file* on previous page.

You can use the following steps to change the information in your SMART Teacher file.

To edit your SMART Teacher file

1. Start Teacher Tools. See *Starting Teacher Tools* on page 20.

Teacher Tools appears.

NOTE

You're unable to edit your classroom name if a class is started.

2. Click **Edit** (the blue underlined text beside the Gradebook name).

The *Edit Gradebook Information* window appears.

3. Edit the information, and then click **Done**.

Adjusting privacy and alert options

You can set the level of student information that appears on your display and define whether you want student sign-in and sign-out alerts to appear.

Using Privacy mode

By default, SMART Response displays student information such as ID numbers and grades. If you don't want to display sensitive information in front of your class you can turn Privacy mode on.

To hide private information

Click the **Privacy: Off** button  in the upper right corner of the screen.

To display private information

Click the **Privacy: On** button  in the upper right corner of the screen.

Changing alerts

You can set SMART Response to display an alert message on your screen when students sign in or out.

NOTE

Alerts appear only when the SMART Response Desktop menu is running.

To set sign-in and sign-out alerts

1. Start Teacher Tools. See *Starting Teacher Tools* on page 20.
Teacher Tools appears.
2. Select **Edit > Preferences** (Windows) or **Teacher Tools > Preferences** (Mac) from the menu bar.
The *SMART Response Preferences* dialog box appears.
3. Click the **Alerts** tab.
4. Select or clear the check boxes for the alerts you want to display or hide, and then click **OK**.

Creating a class list

Before you can start a SMART Response class in Sign In mode, you must have a class list. You can use Teacher Tools to create a list, or you can import one from Microsoft Excel® or a comma separated values (CSV) file.

NOTE

You don't need to create a class list if you're starting the class in Anonymous mode. For more information, see *About Sign In and Anonymous modes* on page 49.

Creating a class list in Teacher Tools

To create a class list

1. Start Teacher Tools. See *Starting Teacher Tools* on page 20.
Teacher Tools appears.
2. Click **Add a Class** in the *Gradebook* area on the left.

CHAPTER 3

Getting started

3. Type a name for your class (for instance, Math), add any optional details in the *Class Information* boxes, and then click **Add**.

After a short delay, the new class's window appears, and the class name appears in the *Gradebook* area.

4. Click the **Students** tab at the top of the window.
5. Click **Add** on the toolbar.

The *Properties* window appears below the table.

6. Type a unique number of 1 to 15 digits in the *Student ID* box.
7. Type a student's name in the *Name* boxes. The student's e-mail address and tags are optional. You can also type name and ID information directly in the table.

NOTE

You can use tags to categorize the students in custom groupings that SMART Response uses when you create student reports.

The student information saves to the class list as you type it.

8. Repeat these steps for each student.

Importing a class list from Excel

IMPORTANT

This feature is supported by SMART Response software for Windows operating systems only.

If you use Microsoft Excel software to maintain class lists, you can import an .xls or .xlsx file into Teacher Tools to create a SMART Response class list. You might find it easier to copy the list of names in your current Excel document into a new spreadsheet.

To create a class list in an Excel spreadsheet

1. Open the Excel spreadsheet containing your students' names.
2. Insert a blank row at the top of the spreadsheet if it doesn't already have one.
3. Type **ID Number** in the first cell (A1).
4. Type **First Name** in the first cell of the second column (B1).
5. Type **Last Name** in the first cell of the third column (C1).
6. Move the first and last names into the columns directly below the headings.

CHAPTER 3

Getting started

7. In column A, type a unique ID number of 1 to 15 digits for each student.

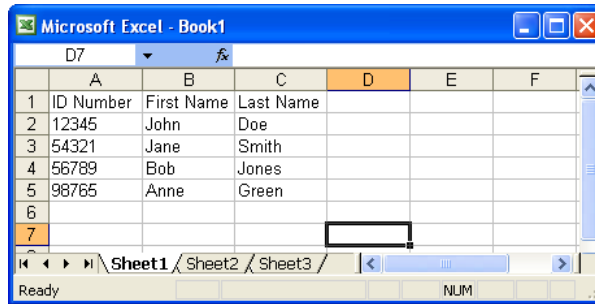

8. Save the spreadsheet.

■ To import a class list from an Excel spreadsheet

1. Start Teacher Tools. See *Starting Teacher Tools* on page 20.

Teacher Tools appears.

2. Click **Add a Class** in the *Gradebook* area on the left.
3. Type a name for your class, add any optional details to the *Class Information* boxes, and then click **Add**.

After a short delay, the new class's window appears, and the class name appears in the *Gradebook* area.

4. Click the **Students** tab at the top of the window.
5. Click the **Import** button at the top of the window, and then select **Students**.

The *Import* dialog box appears.

6. Select the class you want to import the student list into, and then click **Next**.
7. Select **Microsoft Excel** from the *Import from* list, and then click **Next**.
8. Browse to and select the .xls or .xlsx file containing the class list, and then click **Open**.

After a short delay, the names and IDs from the spreadsheet appear in the *Students* page. You can now edit each student's properties, as required.

Importing a class list from a CSV file

If you use a database or spreadsheet program to maintain class lists, you may be able to export class lists as comma separated values (CSV) files. Refer to your database or spreadsheet program's Help or user's guide for more information.

■ To create a class list in CSV format

After exporting your class list as a CSV file, format your file in a text editor so that the first three

CHAPTER 3

Getting started

values are **ID Number**, **First Name** and **Last Name** as shown in this example.

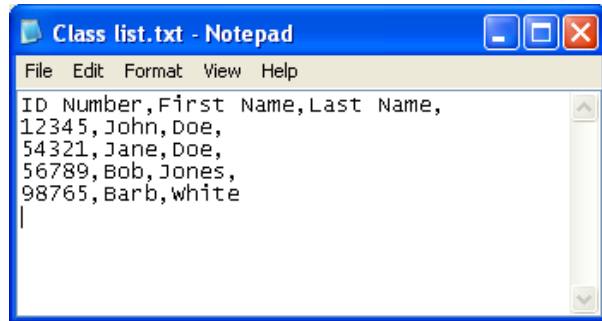

For more information, see *CSV file formatting* below.

■ To import a class list from a CSV file

1. Start Teacher Tools. See *Starting Teacher Tools* on page 20.

Teacher Tools appears.

2. Click **Add a Class** in the *Gradebook* area on the left.
3. Type a name for your class, add any optional details to the *Class Information* boxes, and then click **Add**.

After a short delay, the new class's window appears, and the class name appears in the *Gradebook* area.

4. Click the **Students** tab at the top of the window.
5. Click the **Import** button at the top of the window, and then select **Students**.

The *Import* dialog box appears.

6. Select the class you want to import the student list into, and then click **Next**.
7. Select **Comma Separated Values (CSV)** from the *Import from* list, and then click **Next**.
8. Browse to and select the CSV file containing the class list, and then click **Open**.

After a short delay, the names and IDs from your CSV file appear in the *Students* page. You can now edit each student's properties, as required.

CSV file formatting

Tips for formatting CSV files for importing class lists

The following is the general format you should use for CSV files:

CHAPTER 3

Getting started

```
ID Number, First Name, Last Name
12345, David, Jones
67890, Jane, Doe
56789, John, Swartz
34567, Mary, Smith
```

The order of the columns isn't important, but the first row must contain the column headings identifying what's in each column.

- You must have a column with the heading **ID Number**.
 - You must put a single space between **ID** and **Number**.
 - In place of ID Number, you can use **ID**, **Student ID** or **Number**.
 - If you don't use a correct column name for the **ID Number**, the software is unable to import the list.
- Specify student first and last names in separate columns.
 - For the student's given name, use **First Name** for the column heading.
 - For the student's family name, use **Last Name** as the column heading.
 - You must put a single space between **First** (or **Last**) and **Name**.
 - In place of First Name, you can use **Given Name**.
 - In place of Last Name you can use **Last**, **Family Name** or **Surname**.
- You can also use the heading **Full Name** to import a single value that combines the first and last names.
 - You must put a single space between **Full** and **Name**.
 - In place of Full Name, you can use **Full** or **Name**.
 - If you use **Full Name**, the software checks to see whether the first and last names are separated by a comma (Last, First). If there isn't a comma, it separates the names with a space (First Last).
 - If you put three or more names with spaces between them, the software uses the last word as the last name and joins all of the first words to form the first name. For example, "Michael John Smith" is split with the last name as Smith, and the first name as Michael John.

i NOTE

If your spreadsheet or database software automatically inserts quotation marks around the comma separated values, the software ignores them and the import works properly.

Editing a class list

After you create a class list, you can use Teacher Tools to edit it.

i NOTE

You're unable to edit a class list or remove students from it if a class is running. However, you can add students and import class lists after a class has started.

Editing student information

■ To edit student information

1. Start Teacher Tools. See *Starting Teacher Tools* on page 20.
Teacher Tools appears.
2. Select the class from the *Gradebook* area on the left.
3. Click the **Students** tab.
The class list appears.
4. Select the student whose information you want to edit.
The *Properties* tab appears below the class list.
5. Type the changes into the *Properties* boxes.
6. Repeat steps 4 and 5 for each student.

Adding students to a class list

■ To add a student to a class list

1. Start Teacher Tools. See *Starting Teacher Tools* on page 20.
Teacher Tools appears.
2. Select the class from the *Gradebook* area on the left.

CHAPTER 3

Getting started

3. Click the **Students** tab.

The class list appears.

4. Click **Add** on the toolbar.

The *Properties* tab appears below the class list.

5. Type a unique number of 1 to 15 digits in the *Student ID* box.

The student information saves to the class list as you type it.

6. Type a student's name in the *Name* boxes. The student's e-mail address and tags are optional. You can also type name and ID information directly in the table.

NOTE

You can use tags to categorize the students in custom groupings that SMART Response uses when you create student reports. See *Tagging students* below.

7. Repeat steps 4 to 6 for each student.

Removing students from a class list

To remove a student from a class list

1. Start Teacher Tools. See *Starting Teacher Tools* on page 20.

Teacher Tools appears.

2. Select the class from the *Gradebook* area on the left.

3. Click the **Students** tab.

The class list appears.

4. Select the student you want to remove, and then click **Delete** on the toolbar.

A message appears asking you to confirm the deletion.

5. Click **Yes**.

Tagging students

You can use tags to identify groups or categories of students. SMART Response uses the tags to sort student results when you generate class performance reports. For example, if you assign the tags “Senior” and “Junior” to the students, SMART Response adds a chart to the report, with one bar for each of the two tags.

CHAPTER 3

Getting started

You can assign multiple tags to a student by separating the tags with a semicolon (;), for example “Senior;Honors” and “Junior;Honors”. In this case, SMART Response adds a chart to the report, with three bars (one each for “Senior”, “Junior” and “Honors”).

You can also create tag subcategories by separating the tags with a colon (:). An example would be “Gender:Male” and “Gender:Female”. In this case, SMART Response generates a single report section for “Gender” showing data grouped in “Male” and “Female” subcategories.

Changing a class's passing grade

When you create a class list, you define the passing grade for the class. You can change that grade.

■ To change a class's passing grade

1. Start Teacher Tools. See *Starting Teacher Tools* on page 20.

Teacher Tools appears.

2. Select the class from the *Gradebook* area on the left.
3. Click **Edit** (the blue underlined text beside the class name).

The *Edit Class Information* window appears.

4. Edit the **Passing Grade** value, and then click **Done**.

Chapter 4

Using SMART Response

IN THIS SECTION

About SMART Notebook.....	32
SMART Notebook with SMART Response.....	32
Setting SMART Response preferences in SMART Notebook.....	33
Creating assessments.....	33
Creating an assessment.....	34
Adding content pages to the assessment.....	35
Defining feedback options.....	35
Adding questions to the assessment.....	36
About question types.....	36
Adding questions using the Insert Question wizard.....	38
Importing questions from a Word document.....	39
Example Word document question formats.....	40
Importing questions from an XML or SQZ file.....	41
Importing questions from a PDF file.....	42
PDF document formatting.....	43
Importing questions from ExamView HTML.....	43
Exporting ExamView tests.....	44
About ExamView HTML question importing.....	45
Setting answers for imported questions.....	46
Adding choices to a question.....	47
Tagging questions.....	47
Starting and connecting to a class.....	48
Before class begins.....	48
Safety tips for teachers.....	48
Starting a class.....	49
About Sign In and Anonymous modes.....	49
Starting a class in Sign In mode.....	50
Starting a class in Anonymous mode.....	50
Connecting clickers to the class.....	51
Connecting in Anonymous mode.....	51
Connecting in Sign In mode.....	52
Locking sign-in.....	53

CHAPTER 4

Using SMART Response

Monitoring clickers.....	54
Disconnecting students from a class.....	55
Disconnecting all students.....	55
Disconnecting individual clickers using Teacher Tools.....	55
Students disconnecting manually.....	56
Using clickers.....	56
About Response PE clicker buttons.....	56
Answering yes or no questions.....	57
Answering true or false questions.....	57
Answering multiple choice questions.....	58
Answering multiple answer questions.....	58
Answering number, fraction or decimal questions.....	59
Answering text answer questions.....	60
Changing Response PE clicker settings.....	61
Asking questions.....	61
Completing assessments.....	62
Starting an assessment.....	62
Collecting question responses.....	64
Reviewing results after an assessment.....	65
Previewing results during an assessment.....	66

About SMART Notebook

Use SMART Notebook collaborative learning software to save notes written on a SMART interactive product or at your computer as a series of pages. You can use SMART Notebook software to create a presentation full of colorful clip art, graphics, text and Adobe Flash Player compatible files. Then you can present that SMART Notebook file, keeping your audience's attention as you move and interact with these objects. When your audience provides comments and suggestions, write their input on a page using the pen tray tools or the pen buttons in SMART Notebook.

Because SMART Notebook software works on many platforms, you can share files created on a Windows computer with people who use a Mac computer. You can also export your SMART Notebook file as a cross-platform HTML or PDF file, or as a series of image files.

SMART Notebook with SMART Response

SMART's integration of SMART Response software with SMART Notebook software means that you can create question sets, import questions from Microsoft Word or XML files and start and stop question sessions directly from SMART Notebook software. You can export the class's and individual students' results to a Microsoft Excel file or an HTML page. Using SMART Response's printing feature, create handout materials, copies of the questions and graded results pages for each

CHAPTER 4

Using SMART Response

student and for the class. This section introduces the SMART Response software features in SMART Notebook software. For more information about using other SMART Notebook features, refer to SMART Notebook's online Help or the SMART website.

Setting SMART Response preferences in SMART Notebook

You can customize the default behavior of some of SMART Notebook's SMART Response features.

■ To define how SMART Response inserts instant questions

1. Select **Response > Preferences** from the *SMART Notebook* menu bar.
2. Select one of the following options:
 - If you want the *Insert Question* button to insert the question on a SMART Notebook page that already has notes or images on it, select **Insert on the current page when possible**.
 - If you want to create a new page containing your question, select **Always insert on a new page**.
 - If you want SMART Response to ask you each time, select **Always ask before inserting** (default setting).

■ To define the Response tab options

1. Select **Response > Preferences** from the *SMART Notebook* menu bar.
2. In the *Default chart type for tab results* drop-down list, select **Pie Chart** or **Bar Chart** to define the type of results chart you want to display by default.
3. If you want to display the *Response* tab immediately after you start an assessment so you can immediately monitor the progress of the assessment, select **Show the Response tab when you start an assessment**.
4. If you want to display the *Response* tab immediately after you stop an assessment so you can immediately display the assessment results, select **Show the Response tab when you stop an assessment**.

Creating assessments

You can use SMART Notebook software to create assessments.

CHAPTER 4

Using SMART Response

Creating an assessment

By creating assessments, you can collect results for each question and for the entire assessment at the same time. You can define feedback options that show whether students answered correctly, what the correct answer was and how the class did on the question or the entire assessment.

You can install SMART Response software on any computer to create question sets that you can later copy to and run on the computer system in your classroom.

NOTE

You're unable to run assessment files on a computer with standard SMART Notebook software installed. You must have SMART Notebook software that includes SMART Response.

To create an assessment

1. Click the **SMART Response** icon  in the Windows notification area or Mac menu bar, and then select **Open Notebook Software**.

A blank SMART Notebook page appears.

2. Click the **Response** tab.

TIP

On Windows computers, you can clear the **Auto-hide** option to keep the options visible while you work on your assessment.

3. Click **Title Page**.

The *Insert Title Page* dialog box appears.

4. In the top text box, type a title for your assessment.
5. Select the type of assessment you want to create, and then click **Add**. Optionally, you can type Subject and Topic information.

Title page information appears on the SMART Notebook page, and the Response tab displays several options that enable you to customize your assessment.

To edit the assessment title page and description

1. On the SMART Notebook page, double-click the title, grade, subject or date text to change its properties or edit the text.
2. Click the **Response** tab.

CHAPTER 4

Using SMART Response

3. In the *Description* area, edit the options you defined when you created the assessment.

NOTE

If you edit the SMART Notebook page, the *Description* information doesn't change. Similarly, if you edit the *Description* information, the SMART Notebook page doesn't change.

To add question and content pages to your assessment

See *Adding questions to the assessment* on next page and *Adding content pages to the assessment* below.

To save your assessment

1. Click **Save** .
A Save As dialog box appears.
2. Browse to a folder, type a file name, and then click **Save**.

Adding content pages to the assessment

You can add content pages anywhere in your assessment to introduce questions or provide background information.

To add a content page

1. Create your assessment. See *Creating an assessment* on previous page for more information.
2. Click the **Page Sorter** tab, and then select the page you want to insert a content page after.
3. Click the **Response** tab.
4. Click the **Next Steps** tab.
5. Click **Make the next page a content page**.
A blank page appears.
6. Use SMART Notebook's tools to add text, images or Adobe Flash Player compatible files from the Gallery.

Defining feedback options

Feedback options allow you to show your students their individual grades, the correct answers and the class average.

CHAPTER 4

Using SMART Response

Feedback option	Description
After you stop collecting responses	The students can see how they answered and see their grade after you click Stop . If you select this option, you can also choose to show the correct answers with grades and show class average.
After all questions are answered	The students can see how they answered and see their grade after they finish answering all questions. If you select this option, you can also choose to show the correct answers with grades and show class average.
After each question is answered	The students can see how they answered each question and see their grade after they finish answering all questions. If you select this option, you can also choose to show the correct answers with grades and show class average.
Don't show grades on clickers	The students can't see how they answered or their grades.

■ To define feedback options

1. Create your assessment. See *Creating an assessment* on page 34 for more information.
2. On the *Response* tab for the assessment's title page, select one of the options described in the previous table from the *Show results to students* drop-down list.

Adding questions to the assessment

SMART Response supports up to seven question types depending on the device students use to answer questions.

You can add questions to the assessment using the Insert Question wizard or by importing questions from a Microsoft Word document, XML file, SQZ file, PDF file or ExamView® HTML file.

After you create a question, you can add choices to it or tag it.

About question types

Using SMART Response, you can ask the following types of questions either individually or as question sets. You can also add notes to any question type that appears when you print the question results.

CHAPTER 4

Using SMART Response

i NOTES

- Opinion questions don't have a correct answer and aren't worth points.
- If you include a question of a type not supported in the SMART Response mode you're using, the question appears with an *Unsupported Question Type* icon ⚠ in the *Page Sorter* tab in SMART Notebook.
- Mixed mode supports the same question types as does Standard (Std.) mode.

Question type	Description	Students can answer with					
		Std.	PE	LE	NBSE	XE	VE
Yes or no	Students use the Y or N button to answer a question. You can also choose the Opinion option to allow either answer.	✓	✓	✓	✓	✓	✓
True or false	Students use the True or False button to answer a question. You can also choose the Opinion option to allow either answer.	✓	✓	✓	✓	✓	✓
Multiple choice	Students use a single button, A through J , to answer the question. Select from 2 to 10 answers (2 to 5 answers for SMART Response LE) for a question. You can also choose the Opinion option to allow any answer.	✓	✓	✓	✓	✓	✓
Multiple answer	Students use the A through J buttons to select the correct combination of answers to the question. Select from 2 to 10 answers for the question. You can also choose the Opinion option to allow any combination of answers.	✓	✓		✓	✓	✓

CHAPTER 4

Using SMART Response

Question type	Description	Students can answer with					
		Std.	PE	LE	NBSE	XE	VE
Number, fraction or decimal	Students use the number buttons to answer questions with numeric answers using whole numbers, fractions or decimals. You can also choose the Opinion option to allow any answer.	✓	✓		✓	✓	
Text answer	Students type the answer to the question. You can choose the Opinion option to allow any answer. There is a 20-character (140-character for SMART Response XE) limit on text answer questions.		✓		✓	✓	
Number, fraction, expression	Students use math symbols and numeric values to answer the question. There is a 30-character limit on expression answers.					✓	

Adding questions using the Insert Question wizard

With SMART Notebook software, you can ask your students questions and collect their answers.

■ To add a question using the Insert Question wizard

1. Click the **SMART Response** icon  in the Windows notification area or Mac menu bar, and then select **Open Notebook Software**.

A blank SMART Notebook page appears.

2. Click **Insert Question** on the toolbar.

TIP

If *Insert Question* isn't on the toolbar, you can right-click the toolbar and add it.

The *Insert Question* wizard appears.

3. Click the thumbnail of the question type you want to add, and then click **Next**.

CHAPTER 4

Using SMART Response

4. Type the question in the text box.
5. If you use tags to create categories in your reports, type them in the *Tags* box using the examples, and then click **Next**.
6. For number, fraction or expression questions, type the correct answer or select the **Opinion** option.

For multiple choice or multiple answer questions, select the number of answers, type the answers in the text boxes, click **Next**, and then select the correct answers or the **Opinion** option.

For text answer questions, type one to four acceptable answers or select the **Opinion** option.

NOTE

Text answer questions are case-sensitive. You can enter up to four answers to support different capitalizations (for example, "iron", "Iron" and "IRON").

7. Type the number of points the student receives for a correct answer.

TIP

The value can be a whole or decimal number.

8. If you want to create more questions, click **Insert Another**, and then repeat steps 2 to 7.
9. Click **Finish**.
10. Optionally, use SMART Notebook's tools to add images or Adobe Flash Player compatible files from the Gallery.

Importing questions from a Word document

IMPORTANT

This feature is available only with SMART Response software for Windows computers.

When you import questions from a Microsoft Word document, SMART Response's conversion utility uses a variety of techniques to identify which paragraphs are questions, which are possible answers and what type of question to create. Its most basic technique is to interpret the numbering of the paragraphs. The software also searches for key words when parsing the paragraphs. The software then converts the paragraphs into SMART Notebook assessment pages. See *Example Word document question formats* on next page for more information.

NOTE

SMART Response is unable to provide the correct answers to imported questions.

■ **To import questions from a Word document**

1. Click the **SMART Response** icon  in the Windows notification area, and then select **Open Notebook Software**.
A blank SMART Notebook page appears.
2. Select **Response > Import Question From > Microsoft Word**.
The *Open* dialog box appears.
3. Browse to and select the Word document, and then click **Open**.
A progress bar appears and closes when the conversion is complete.
4. In the *Page Sorter* tab, select the thumbnail for the title page.
5. Optionally, edit and customize the title page and description.
6. In the *Page Sorter* tab, select the thumbnail for the first question page and check it carefully to verify that the conversion process was successful.
7. Repeat step 6 for all questions in the assessment.

After importing the questions, see *Setting answers for imported questions* on page 46.

Example Word document question formats

The following list of questions is an example of how to format your Word document before importing it into SMART Response.

1. According to the U.S. Census Bureau, the majority of poor children live in:
 - a. urban areas
 - b. suburban areas
 - c. rural areas
2. Can you fill a 10 L aquarium with five 2 L pitchers of water?
Yes
No
3. True or false: Half of all even whole numbers are divisible by 4.
True
False

CHAPTER 4

Using SMART Response

- Let $x = 3$. Compute y from the equation below.

$$y = 20 - 4x$$

Answer: _____

- Which Native American group lived in the highlighted area on the map?
 - Kwakiutl
 - Sioux
 - Iroquois

NOTE

Ensure that you format the questions in your Word document like the ones in these examples before you import the file. In most cases, the import utility ignores headers and footers in the Word document.

Importing questions from an XML or SQZ file

SMART Response includes an import feature for converting questions from ExamView format XML files or SMART Sync™ classroom management software SQZ files into question sets. SMART Response uses the tags in the XML and SQZ files to extract questions, answers and correct responses, and then converts the information into assessment pages.

IMPORTANT

You must have or create an ExamView formatted XML text file or a SMART Sync software SQZ file before you can perform this procedure. Binary ExamView formatted files are not supported.

To import questions from an XML or SQZ file

- Click the **SMART Response** icon  in the Windows notification area or Mac menu bar, and then select **Open Notebook Software**.

A blank SMART Notebook page appears.
- Select **Response > Import Question From > XML**.

The *Open* dialog box appears.
- Browse to and select an XML or SQZ file, and then click **Open**.

A progress bar appears, followed by the title page for the new question set.
- In the *Page Sorter* tab, select the thumbnail for the first question page.
- Add a title page to the assessment, and then customize the page and description as desired.

CHAPTER 4

Using SMART Response

6. Edit and customize the first question page as desired.

Check the question carefully, including the correct answer (see below), to verify that the conversion process was successful.

7. Repeat step 6 for all questions in the set.

8. Click **Save** .

A *Save As* dialog box appears.

9. Browse to a folder, type a name for the file, and then click **Save**.

After importing the questions, see *Setting answers for imported questions* on page 46

Importing questions from a PDF file

IMPORTANT

This feature is available only with SMART Response for Mac computers.

When you import questions from a PDF file, the SMART Response conversion utility interprets the numbering of the paragraphs. The software also recognizes key words when parsing the paragraphs. The software then converts the paragraphs into SMART Notebook assessment pages.

IMPORTANT

Ensure that you format the questions in your PDF file like the ones in *PDF document formatting* on next page before you begin this procedure.

To import questions from a PDF file

1. Click the **SMART Response**  icon in the Mac menu bar, and then select **Open Notebook Software**.

A blank SMART Notebook page appears.

2. Select **Response > Import Question From > PDF File**.

The *Open* dialog box appears.

3. Browse to and select the PDF file, and then click **Open**.

A progress bar appears and closes when the conversion is complete.

4. In the *Page Sorter* tab, select the thumbnail of the title page.
5. Edit and customize the title page and description.

CHAPTER 4

Using SMART Response

6. Edit and customize the first question page.
7. Check the question carefully to verify that the conversion process was successful.
8. Repeat steps 6 and 7 for all questions in the assessment.

After importing the questions, see *Setting answers for imported questions* on page 46

PDF document formatting

The text below shows examples of multiple choice questions formatted so that SMART Response software can easily convert them to question pages.

1. How is the boy involved in the dog's care?
 - a. He feeds the dog twice a day.
 - b. He walks the dog once a day.
 - c. He cleans up the dog's messes.
 - d. He gives the dog a lot of affection.
2. What percentage of the U.S. Government budget goes to welfare and Social Security?
 - a. 25% to welfare and 25% to Social Security
 - b. less than 1% to welfare and 20% to Social Security
 - c. 20% to welfare and 1% to Social Security
 - d. less than 1% to welfare and less than 1% to Social Security

NOTES

- You can import only multiple choice questions.
- You should remove headers and footers from your PDF file because the import utility will attempt to convert them into questions.
- Introduction, background or source information not related to questions should be on separate pages.
- Text and graphics that the import utility can't convert into questions are imported to a SMART Notebook page as a graphic.

Importing questions from ExamView HTML

You can import ExamView 5.2.0 and 6.2.1 HTML question files into a SMART Response assessment. See *Exporting ExamView tests* on next page for information about exporting HTML question files from ExamView.

i NOTE

SMART Response is unable to provide the correct answers to imported questions.

To import questions from an ExamView HTML file

1. Click the **SMART Response** icon  in the Windows notification area or Mac menu bar, and then select **Open Notebook Software**.

A blank SMART Notebook page appears.

2. Select **Response > Import Question From > ExamView HTML**.

The *Open* dialog box appears.

3. Browse to and select the HTML file, and then click **Open**.

A progress bar appears and closes when the conversion is complete.

4. In the *Page Sorter* tab, select the thumbnail for the title page.

5. Optionally, edit and customize the title page and description.

6. In the *Page Sorter* tab, select the thumbnail for the first question page and check it carefully to verify that the conversion process was successful.

See *About ExamView HTML question importing* on next page for information about how ExamView questions are converted to SMART Response questions.

7. Repeat step 6 for all questions in the assessment.

After importing the questions, see *Setting answers for imported questions* on page 46.

Exporting ExamView tests

You can export ExamView 5.2.0 and ExamView 6.2.1 online tests as HTML documents.

To export an HTML test document from ExamView 5.2.0

1. In ExamView Test Generator 5.2.0, select **File > Publish Online Test**.

The *Publish Online Test* dialog box appears.

2. In Step 1, type a title for the assessment.

3. In Step 2, select the **Save test as an HTML document to your hard drive** option, and then click **Next**.

CHAPTER 4

Using SMART Response

- In Step 3, select the **Publish a study guide** option, and then click **Next**.

TIP

You can also select the **Show Rational**, **Show Feedback** and **Show Reference** options. SMART Response converts any notes in the rational, feedback and reference boxes to SMART Notebook notes.

- Type a file name for the HTML file, and then click **OK**.

ExamView creates the HTML file and a **_files** folder containing all the image files used in the test.

To export an HTML test document from ExamView 6.2.1

- In ExamView Test Generator 6.2.1, select **File > Export to HTML**.

The *Export to HTML* dialog box appears.

- Type a title for the assessment, select the **Export as study guide** option, and then click **OK**.

TIP

You can also select the **Show Rational**, **Show Feedback** and **Show Reference** options. SMART Response converts any notes in the rational, feedback and reference boxes to SMART Notebook notes.

- Type a file name for the HTML file, and then click **OK**.

ExamView creates the HTML file.

About ExamView HTML question importing

The following table shows how SMART Response imports ExamView HTML question files.

ExamView question type	Imports as this SMART Response question type
True or false	True or false
Modified true or false This is a two-part question: if the answer is false, the student modifies the question to make it true.	True or false
Multiple choice	Multiple choice Choice labels are imported in uppercase letters. Custom choice labels aren't imported.

CHAPTER 4

Using SMART Response

ExamView question type	Imports as this SMART Response question type
Multiple answer	Multiple answer Choice labels are imported in uppercase letters. Custom choice labels aren't imported.
Yes or no	Yes or no
Numeric response	If the original answer is a decimal or fraction value, then it imports as a Numeric, decimal, fraction question. If the original answer is a math expression, then it imports as an Opinion Numeric, fraction, expression question.
Short answer or text answer	Text answer Only the first 20 characters of the answer are imported.
Matching	Content page
Problem	Text answer Only the first 20 characters of the answer are imported.
Essay	Text answer Only the first 20 characters of the answer are imported.
Case	Text answer Only the first 20 characters of the answer are imported.
Other	Text answer Only the first 20 characters of the answer are imported.

Setting answers for imported questions

After importing questions, you can set or change the answers to your assessment's questions.

■ To set the answers for imported questions

1. In the *Page Sorter* tab, select the thumbnail for the first question page.
2. Select **Response > Set All Answers**.
The *Set All Answers* dialog box appears.
3. Type or select the correct answers from the options for all questions, and then click **Done**.
4. Click **Save** .
A *Save As* dialog box appears.
5. Browse to a folder, type a file name, and then click **Save**.

You can run the question set on this computer or copy the SMART Notebook file to any computer that has SMART Response installed.

Adding choices to a question

After you create a question, you can add choices to it.

To add a choice to a question

1. Click the **Page Sorter** tab.
2. Select the thumbnail of the question page you want to add a choice to.
3. Select **Response > Add Choice**.
4. Follow the on-screen instructions.
5. If you have to change the correct answer for the question, select **Response > Set All Answers**, and then make the changes.

NOTE

If you add choices to true/false; yes/no; number/fraction/decimal or text answer questions, the question changes to multiple choice.

Tagging questions

Using the Insert Question wizard, you can add tags to the questions you create in SMART Notebook assessments. You can also add or change the tags to questions after you finish creating an assessment.

You can use tags to identify groups or categories of questions. SMART Response software uses the tags to sort responses to questions when you generate Student Performance and Class Performance reports. For example, if you assign the tags "Difficult" and "Easy" to the questions, SMART Response software creates a chart in the report for questions with "Difficult" and "Easy" tags.

You can assign multiple tags to a question by separating the tags with a semicolon (;), for example, "Science;Nature" and "Science;Astronomy". SMART Response then generates one chart with three bars for "Science", "Nature" and "Astronomy".

You can also create tag subcategories by separating the tags with a colon (:), for example, "Science:Basic" and "Science:Advanced". In this case, SMART Response software generates a single report section for "Science" showing data grouped into "Basic" and "Advanced" subsections.

To add or change tags in existing questions

1. Click the **SMART Response** icon  in the Windows notification area or Mac menu bar, and then select **Open Notebook Software**.

CHAPTER 4

Using SMART Response

A blank SMART Notebook page appears.

2. Select **File > Open**, and then select your assessment file.

The SMART Notebook file appears displaying the title page.

3. Select the thumbnail for the question page you want to add tags to.

The question page appears.

4. Click the **SMART Response** tab, and then select the **Properties** tab.
5. If the *Tags* box isn't visible, click **Show** beside the *Answer Key* heading.
6. Type your tags in the *Tags* box. When you finish, click on the page.
7. Press **Page Up** or **Page Down** to select other questions as required, and then repeat step 6.
8. Save your assessment.

Starting and connecting to a class

To use SMART Response interactive response system in your classroom, you must start a class and allow students to connect to it. You can monitor the student connections during the class and disconnect them when the class is done.

Before class begins

Safety tips for teachers

When using SMART Response with a SMART Board interactive whiteboard and a projector:

- Tell students not to look directly at the light beam from the projector. Instead, encourage them to keep their back to the projector when working at the interactive whiteboard. Before they turn to face the class, they should take a big step (or two) sideways.
- Make sure you don't look directly into the light beam from the projector. Keep your back to the class when you write over a projected image. Step to the side of the interactive whiteboard before you turn to face the class.
- Tell your students not to touch the projector, because it can become extremely hot during normal operation.
- Don't use a chair to increase a student's reach. If your students can't reach the top of the interactive whiteboard, lower it. You may need to remount a wall-mounted unit to a lower position. If your interactive whiteboard is mounted on a floor stand, lower it with the help of another adult.

CHAPTER 4

Using SMART Response

- Tell students not to run in the vicinity of the floor stand, because they could trip over the floor stand's feet.

Starting a class

You can start a class in Sign In mode or Anonymous mode.

About Sign In and Anonymous modes

Before starting a class session, you must decide whether you want the system to operate in Sign In mode or Anonymous mode. This table summarizes the characteristics of each mode.

Sign In mode	Anonymous mode
Teachers use a class list that identifies each student by name and ID number.	Teachers can operate the system without a class list.
Students can connect to the class, but they must sign in with their assigned ID number.	Students can connect to the class without identifying themselves.
Teachers can control when students can sign in by locking a class.	Teachers can't control when a student can sign into their class.
Under the teacher's control, students can see their own grades, but they can't see any other students' grades.	Under the teacher's control, students can see their own grades, but they can't see any other students' grades.
If the <i>Remember names</i> check box is selected, teachers can identify individual students as they connect to the class.	Teachers can see how many students are connected.
Teachers can use Gradebook to save and analyze student and class performance over time.	Teachers are unable to save and analyze student and class performance over time.
Teachers can generate student and class reports.	Teachers are unable to generate student or class performance reports.
Teachers can see, export and print the total class grade.	Teachers can see, export and print the total class grade.
Teachers can see, export and print total scores for each question.	Teachers can see, export and print total scores for each question.
Teachers can see, export and print each student's grade for each question and for the whole assessment.	Teachers are unable to identify student names or individual grades.
Teachers can review results during the assessment in the <i>Response</i> tab for the class as a whole and for individual students (if the <i>Remember names</i> check box is selected).	Teachers can view results for the class as a whole during the assessment in the <i>Response</i> tab.

CHAPTER 4

Using SMART Response

Starting a class in Sign In mode

When you use SMART Response interactive response system in Sign In mode, you can monitor each student's responses and create reports on student and class performance. For more information, see *About Sign In and Anonymous modes* on previous page.

NOTE

Before you can start a SMART Response interactive response system class and have students connect in Sign In mode, you must have a class list. If you don't have a class list, you can create or import class lists. See *Creating a class list* on page 23.

To start a class in Sign In mode

In SMART Notebook software select **Response > Start Class**, and then select the class you want to start.

The receiver's Ready light flashes and then turns solid green, and the receiver's Transmit light flashes green. You can now ask the students to connect to the class.

NOTE

You can also start a class in Teacher Tools.

Starting a class in Anonymous mode

You don't need a class list to operate SMART Response in Anonymous mode. See *About Sign In and Anonymous modes* on previous page for more information.

To start a class in Anonymous mode

In SMART Notebook software select **Response > Start Class**, and then select **Anonymous Mode**.

The receiver's Ready light flashes and then turns solid green, and the receiver's Transmit light flashes green. You can now ask the students to connect to the class.

i NOTES

- You can start a class and the assessment at the same time in SMART Notebook software by selecting **Response > Start Assessment**.

If you don't have a class list, the class starts in Anonymous mode. If you do have a class list, a list of classes appears where you can select Anonymous mode.

- You can also start a class in Teacher Tools.
- If the students are already signed in to a class, when you select *Anonymous Mode*, the clickers switch to Anonymous mode.
- If the students are connected in Anonymous mode, and you start a class that requires sign-in, the students are signed off and then asked to sign in.

Connecting clickers to the class

After you start a class, you can tell your students to connect to the class.

How the students connect to the class depends on SMART Response software's current mode. In addition, you can prevent students and clickers from signing in.

Connecting in Anonymous mode

You must start a class in Anonymous mode before your students connect their clickers. See *Starting a class in Anonymous mode* on previous page.

👉 IMPORTANT

In this mode, students must know the class name.

When the "SMART Response is ready to use" balloon message appears, tell your students to follow this procedure.

To connect in Anonymous mode

1. Press the clicker's **Power** button for one second.

A message appears asking if you want to join the last class the clicker was connected to or find a different class.

A "Hello" message appears on the clicker display.

CHAPTER 4

Using SMART Response

2. Press the **Enter** button to join the last class.

OR

Press the **Down** button to select **Find a class**, and then press **Enter**.

The clicker scans for classes, and then displays a list of classes within range. Press the **Up** and **Down** buttons to select the correct class, and then press **Enter**.

3. Press the **Enter** button to connect.

NOTES

- If you selected the *Lock Sign In* option, the student sees a “Fail to login” message. If this occurs, unlock Sign In, and then tell the students to reconnect.
- When all of your students are connected, you can start asking questions. Refer to *Creating assessments* on page 33 for information about using SMART Notebook software to ask questions and create assessments.

Connecting in Sign In mode

You must start a class in Sign In mode before your students connect their clickers. See *Starting a class in Sign In mode* on page 50.

IMPORTANT

When connecting to a class in Sign In mode, students must know the classroom name. They must also sign in with a unique ID number.

After you start a class, ask your students to follow these steps.

To connect in Sign In mode

1. Press the clicker's **Power** button for one second.

A message appears asking if you want to join the last class the clicker was connected to or find a different class.

2. Press the **Enter** button to join the last class.

OR

Press the **Down** button to select **Find a class**, and then press **Enter**.

The clicker scans for classes, and then displays a list of classes within range. Press the **Up** and **Down** buttons to select the correct class, and then press **Enter**.

A connecting message appears, followed by a message asking for an ID number.

CHAPTER 4

Using SMART Response

3. Press the number buttons to enter your ID number, and then press **Enter**.

If the ID is valid, a message appears asking you to confirm your name.

NOTE

If the teacher selected the *Lock Sign In* option, a message appears on the clicker indicating that the student can't sign in at this time, and then a *Retry* option appears.

4. Press the **Enter** button to connect.

A welcome message appears.

When all of your students are connected, you can start asking questions. Refer to *Creating assessments* on page 33 for information about using SMART Notebook software to ask questions and create assessments.

NOTE

If a student attempts to sign in using an ID that another student is already using, a message appears indicating that they're unable to sign in and lets them retry.

Locking sign-in

You can block students from signing in to your class. Select the **Lock Sign In** button to block students from signing in before you're ready or to block late students from signing in. When you start a class, sign-in is unlocked by default. If you stop and restart SMART Response or open a new class list, sign-in is unlocked.

NOTE

Sign-in locking is available only in Sign In mode.

To block students from signing in

1. Start Teacher Tools. See *Starting Teacher Tools* on page 20.

Teacher Tools appears.

2. If a class isn't already started, select a class in the *Gradebook* area, and then click **Start Class**.

3. Click **Lock Sign In**.

Students are unable to sign in.

i NOTE

If students disconnect from your class when sign-in is locked, they're unable to sign in again until you click **Unlock Sign In**.

Monitoring clickers

You can use Teacher Tools to check the status of each clicker. You can see if a clicker is logged on or if it's in Anonymous mode. If the clicker is logged on, you can also see the student's name. You can see each clicker's hardware ID (MAC address) and identify which logged-on student is using it.

The display shows the signal strength of each clicker, as measured by the receiver. If the signal level is low for one or more clickers, and they are having communication problems, you can reposition the receiver or remove signal path obstructions.

■ To monitor clickers

1. Start a class and have your students connect their clickers.

The SMART Response receiver indicator lights are green.

2. Start Teacher Tools. See *Starting Teacher Tools* on page 20.

Teacher Tools appears.

3. Click the **Devices** button in the left column.

The *Devices* window appears and displays a "Your SMART Response receiver is connected and working" message. The receiver name appears below the Devices button.

i NOTE

If a "Your SMART Response receiver is not connected" message appears, the SMART Response receiver isn't connected or isn't working properly. Check the receiver connections or repeat the receiver installation.

4. Click **My Receiver**, and then click the **Clickers** tab at the top of the window.

The *Clickers* window appears and displays a table of all connected clickers. Each row of the table shows one clicker's signal strength, battery condition, student name and hardware ID (MAC address).

i NOTE

If students' clickers are connected anonymously, the *Student Name* field displays *Anonymous*.

Disconnecting students from a class

You can disconnect the students from a class in three ways.

Disconnecting all students

You can disconnect all students simultaneously.

■ To disconnect all students by stopping the class

In SMART Notebook select **Response > Stop Class**.

All student clickers disconnect.

A message appears on the clickers indicating that the class is over and that the clickers are turning off. The Transmit and Receive lights on the receiver turn off and the Ready light turns red.

Disconnecting individual clickers using Teacher Tools

i NOTE

This option is available only if the students are connected to a class in Sign In mode.

■ To disconnect individual clickers using Teacher Tools

1. Start Teacher Tools. See *Starting Teacher Tools* on page 20.

Teacher Tools appears.

2. Select the active class in the *Gradebook* area.

3. Click the **Students** tab.

4. Select the row of the student you want to disconnect.

The *Properties* window appears below the student list table.

5. Click **Disconnect Clicker**  at the top-right of the window.

The *Log Off Student* dialog box appears.

CHAPTER 4

Using SMART Response

6. Click **OK** to disconnect the student.

NOTE

The student can log back on immediately.

OR

If you don't want the student to be able log on for a while, select **Also ban this student for**, select the number of minutes, and then click **OK**.

Students disconnecting manually

Students can disconnect their clickers by pressing the **Power** button for one to two seconds.

If signed-in students turn off their clickers when a question set is started, they can turn on the clickers, sign in with the same ID and join the assessment in progress without losing any previous answers. If students are connected anonymously, they lose any previous answers when they reconnect.

They can then connect and sign in to the correct class without turning off their clickers.

In Sign In mode, if students disconnect during an assessment, they can sign in with the same ID to join the assessment without losing the answers they previously entered. In Anonymous mode, students lose any previously entered answers when they reconnect.

If students connect to the wrong class, ask them to sign out by clicking **Disconnect**, and then to sign in to the correct class.

Using clickers

After students connect their clickers to your class, they can use their clickers to complete assessments.

In addition, students can ask questions using their clickers and change the clicker settings.

About Response PE clicker buttons

CHAPTER 4

Using SMART Response



Answering yes or no questions

Students can answer yes or no questions using the following two buttons on their clickers:



i NOTE

These are the same buttons students use to answer true or false questions.

Answering true or false questions

Students can answer true or false questions using the following two buttons on their clickers:



i NOTE

These are the same buttons students use to answer yes or no questions.

CHAPTER 4

Using SMART Response

Answering multiple choice questions

Students can answer multiple choice questions using the following buttons on their clickers:

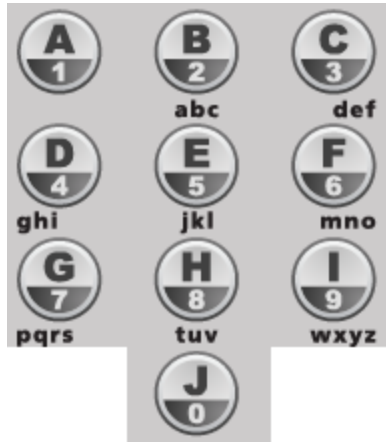

EXAMPLE

To answer C, a student would press



Answering multiple answer questions

Students can answer multiple answer questions using the following buttons on their clickers:

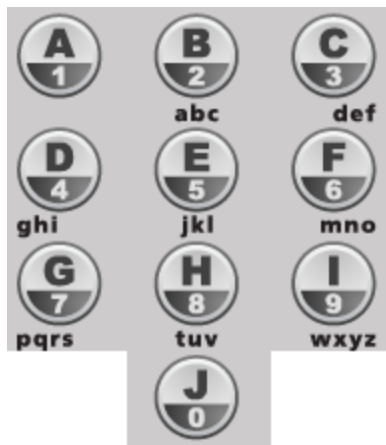

EXAMPLE

To answer A and C, a student would press



and then press



.

CHAPTER 4

Using SMART Response

Answering number, fraction or decimal questions

Students can enter numbers using the following buttons on their clickers:





■ To enter a decimal number

1. Enter the numbers to the left of the decimal point.
2. Press .
3. Enter the numbers to the right of the decimal point.

■ To enter a fraction

1. Enter the numerator
2. Press .
3. Enter the denominator.

■ To enter a mixed fraction

1. Enter the whole number
2. Press .
3. Enter the numerator.
4. Press .
5. Enter the denominator.

CHAPTER 4

Using SMART Response

- To change a number from positive to negative (or vice versa)

Press .

Answering text answer questions



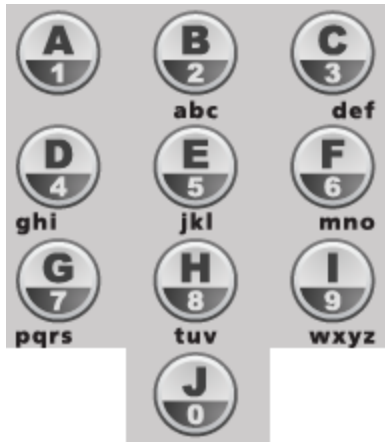





Students can answer text questions using the following buttons on their clickers:



Responding to text answer questions on a SMART Response PE clicker is similar to texting on a cell phone.

EXAMPLE

To respond "iron", a student would do the following:

1.  Press  three times to enter *i*.
2.  Press  three times to enter *r*.
3.  Press  three times to enter *o*.
4.  Press  two times to enter *n*.

 **IMPORTANT**

Text answers are case sensitive. If the only acceptable answer to a text answer question is "Iron", students must enter "Iron" and not "iron" or "IRON". To change to uppercase, students press  on their clickers.

 **To enter a space**

Press  .

 **To make a change**

1. Use the arrow buttons to move the cursor to the character you want to change.
2. Press the **Delete** button to delete the character.
3. Enter a new character.

Changing Response PE clicker settings

Students can press the **Menu** button at any time to log off the session or to modify the clicker's settings. These options are available in the menu:

Option	Description
Sign out	Press to log off a class without turning off the clicker.
Language	Press to select the language displayed on the clicker's LCD display.
Contrast	Press to lighten or darken the clicker's LCD display. Use the up and down arrows to increase or decrease the contrast.
Device info	Press to display the clicker's MAC address and firmware version.
Advanced	You must have a valid security code to open this menu. Your customer support representative can provide the code to help troubleshoot clicker problems.

Asking questions

At any time during a class, students can request the teacher's attention by pressing the **Ask Question** button on their clicker. Teacher Tools displays the number of students who have questions on the *Home* tab beside the *Questions* heading.

■ To identify students with questions

1. Click the **Students** tab to show the list of student names and IDs.
2. In the *Status* column, you might see one or more rows with a question icon .
3. After you answer a student's question, select the row that displays the student's name, and then click **Clear Question** in the top-right corner of the *Properties* window.

Completing assessments

After you create an assessment, you can start it in SMART Response. Students then complete the assessment using their clickers. During the assessment, you can view results.

Starting an assessment

When you use SMART Notebook software to ask questions, SMART Response uses the options you set in Teacher Tools to control how students interact with the teacher. Before starting a SMART Response assessment, check that the receiver is connected and ready. If you don't have a SMART Notebook assessment file, you must create one. See *Creating an assessment* on page 34 for more information.

■ To open and set assessment options

1. Click the **SMART Response** icon  in the Windows notification area or Mac menu bar, and then select **Open Notebook Software**.

A blank SMART Notebook page appears.

2. Select **File > Open**.
3. Select the SMART Notebook file containing your questions, and then click **Open**.

The assessment file's title page appears.

4. Click the **Response** tab, and then click **Properties** if it isn't already selected.

CHAPTER 4

Using SMART Response

5. Select the **Remember names** check box to display student names in the *Response* tab during the assessment.

OR

Clear the **Remember names** check box to hide student names in the *Response* tab during the assessment.

NOTES

- Select the **Remember names** check box if you want to identify students when reviewing results during the assessment.
- Clear the **Remember names** check box if you want to display the SMART Notebook file on a SMART Board interactive whiteboard during the assessment but don't want students to see each other's results. (You can review, print and export the results after the assessment even if you clear the **Remember names** check box.)

6. From the *Show results to students* drop-down list, select one of the following options:

Feedback option	Description
After you stop collecting responses	The students can see how they answered and see their grade after you click Stop . If you select this option, you can also choose to show the correct answers with grades and show class average.
After all questions are answered	The students can see how they answered and see their grade after they finish answering all questions. If you select this option, you can also choose to show the correct answers with grades and show class average.
After each question is answered	The students can see how they answered each question and see their grade after they finish answering all questions. If you select this option, you can also choose to show the correct answers with grades and show class average.
Don't show grades on clickers	The students can't see how they answered or their grades.

To start an assessment and ask questions

1. If you haven't started a class, start it now.
2. If the students haven't connected to the class, have them do so now.

CHAPTER 4

Using SMART Response

3. Select **Response > Start Assessment**.

The *Response* tab opens with the *Progress* button selected.

If you're projecting the questions on a screen, you can control the students' progress by selecting each question page in turn.

4. Use the menu bar **Forward**  or **Back**  buttons to open a question page.
OR

Click the **Page Sorter** tab, and then select the thumbnail of a question page.

5. Click **Response > Stop Assessment** in the menu bar to end the session.
6. If you chose to show results to students, select **Response > End Review Mode** when the students are done reviewing their results.
7. Click **Save**  to save the results.

Collecting question responses

NOTE

Make sure that you start your class and that all the students are connected before you ask questions.

To collect question responses

1. Select **Response > Start Assessment**.

If you haven't started a class, a message appears asking you to select a class. Select a class, and then click **Start Class**.

A message appears on the clickers asking the students to respond.

2. After all students answer the questions, select **Response > Stop Assessment**.

NOTE

SMART Notebook software stores the results in your document. Remember to save your document after collecting responses.

3. If you want to save the questions as a SMART Notebook file, select **File > Save** (or **Save As**).
A *Save As* dialog box appears.
4. Browse to a destination folder, type a file name, and then click **Save**.

Reviewing results after an assessment

You can use SMART Response to collect and display results instantly after you run an assessment. You can use assessments as an interactive learning tool and a way to give students continual feedback about what they're learning.

■ To display instant class assessment results

1. After all students answer the questions, return to the assessment's title page.
2. Click SMART Notebook's **Response** tab if it isn't already open.
3. Select **Progress > Stop this assessment**.

The *Progress* button changes to *Results*. A summary of the class's performance appears, including a chart showing the class's responses to each question.

4. If you want to view more detailed class results, click **Show** beside *Details*.

A list of students, their grades and the duration of the assessment appears.

NOTES

- Use discretion when displaying sensitive grade information to all class members. If you started the class in Sign In mode, consider clearing the *Remember names* check box before you start the assessment to hide student names in the *Response* tab. (You can later review, print and export the results in Teacher Tools.)
- If you started the class in Anonymous mode or cleared the *Remember names* check box before you start the assessment, student names display as *Anonymous-1*, *Anonymous-2*, and so on.

■ To display instant results for each question

1. After all students answer the questions, return to the assessment's title page.
2. Click SMART Notebook's **Response** tab if it isn't already open.
3. Select **Progress > Stop this assessment**.

The *Progress* button changes to *Results*. A chart representing the class's performance appears.

4. Click the **Page Sorter** tab, and then select the question.
5. Click the **Response** tab.

CHAPTER 4

Using SMART Response

6. Click **Results**.

A summary of the class's responses to the question appears, including a chart showing the number of responses to each possible answer.

 **TIPS**

- You can change the type of chart displayed by selecting **Show bar chart** or **Show pie chart**.
- You can insert the chart into the question page by clicking **Insert chart into Notebook**.

7. Click **Show** beside *Details*.

A list showing each student's submitted response appears, including the time it took to respond.

 **NOTES**

- Use discretion when displaying sensitive grade information to all class members. If you started the class in Sign In mode, consider clearing the *Remember names* check box before you start the assessment to hide student names in the *Response* tab. (You can later review, print and export the results in Teacher Tools.)
- If you started the class in Anonymous mode or cleared the *Remember names* check box before you start the assessment, student names display as *Anonymous-1*, *Anonymous-2*, and so on.

Previewing results during an assessment

You can use SMART Response to display results instantly while you run an assessment. You can use assessments as an interactive learning tool and a way to give students continual feedback about what they're learning.

 **IMPORTANT**

You must have two or more students participating in your assessment to use this feature.

To preview class assessment results

1. Start your assessment, if it isn't already running.
2. Using the Page sorter, or the left and right arrows, display the question.
3. Click SMART Notebook's **Response** tab, and then select the **Progress** button.

CHAPTER 4

Using SMART Response

4. Click **Show** beside *Results Preview*.

A chart showing the class's current responses to the question appears.

NOTES

- The chart changes as students answer the question, and changes as students change their answers.
- Select the assessment's title page to preview a summary of the progress of all the assessment's questions. You can use this chart to see how much of the assessment their class has completed.

Chapter 5

Reviewing, printing and exporting assessment results

The Teacher Tools Gradebook gives you quick access to test results, making it easy to prepare reports and conduct evaluations. Reports can be as simple or as detailed as you need. Create high-level comparisons of class performance, specific reports based on tagged characteristics such as demographics or curriculum standards, or personalized reports on how individual students perform. You can also create reports that show grades for the entire school year.

i NOTE

Assessment results for students aren't saved in Anonymous mode.

You can display results and generate reports to review during an assessment or after you run an assessment. In addition, you can print or export questions and assessment results.

IN THIS SECTION

Importing assessment results.....	69
Formatting the results files for importing.....	70
Importing a class results file.....	70
CSV and XLS file formatting.....	71
Reviewing assessment results.....	71
Flagging results.....	74
Generating student performance reports.....	75
Generating class performance reports.....	76
Printing and exporting questions and results.....	76
Printing from SMART Notebook's Response menu.....	76
Exporting results.....	78

Importing assessment results

You can import the results of an assessment that you performed without SMART Response. You can then generate reports combining the results from your assessments with the imported results.

CHAPTER 5

Reviewing, printing and exporting assessment results

You can import results using either comma separated values (CSV) files or Microsoft Excel files (Windows only).

NOTE

The ID numbers you use in the list you import must match the ID numbers assigned to the students in the class list that you're using.

Formatting the results files for importing

You must use the headings **ID Number** and **Marks** when you format the CSV, XLS or XLSX files for importing. If you're using information from another program, copy it to a new file and then format it as shown in *CSV and XLS file formatting* on next page.

Importing a class results file

To import a class results file

1. Start Teacher Tools. See *Starting Teacher Tools* on page 20.
Teacher Tools appears.
2. In the *Gradebook* area, select the class you want to import the results to.
3. Click **Import** on the menu bar, and then select **Assessments**.
4. Click the target class, and then click **Next**.
5. Type the title, and then select the type of the assessment. Optionally, you can type the subject and topic information.
6. Select the **Percentage** or **Raw values** score formats, and then click **Next**.
7. Select the file type, and then click **Next**.
8. Browse to and select the file, and then click **Open**.

The student results information appears in the *Students* and *Assessments* tabs. You can also generate reports that include the imported scores.

CHAPTER 5

Reviewing, printing and exporting assessment results

CSV and XLS file formatting

EXAMPLE

Comma separated values (CSV) file

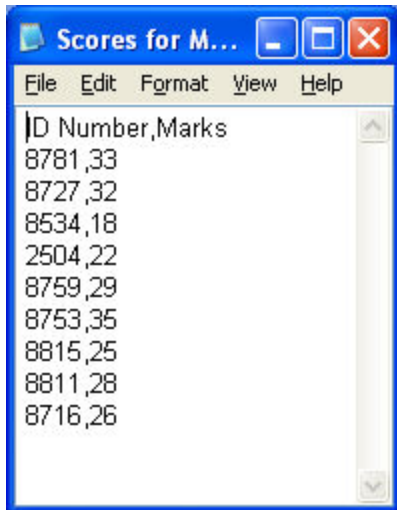

EXAMPLE

Excel spreadsheet (XLS) file

	A	B	
1	ID Number	Marks	
2	8781	33	
3	8727	32	
4	8534	18	
5	2504	22	
6	8759	29	
7	8753	35	
8	8815	25	
9	8811	28	
10	8716	26	
11			

Reviewing assessment results

After you run and stop an assessment, Teacher Tools records the class results and each student's results. At any time after you run an assessment, you can review the student, question or assessment results and performance.

CHAPTER 5

Reviewing, printing and exporting assessment results

NOTE

Use discretion when displaying sensitive information to all class members. To hide sensitive information, click the **Privacy: Off** indicator before you display student or assessment results. See *Adjusting privacy and alert options* on page 22 for more information.

To display student results

1. If a class is currently running, stop it.
2. In Teacher Tools, select the class name in the *Gradebook* area.
The *Teacher Tools* window appears with the *Home* tab selected.
3. Click the **Students** tab.

After a short delay, a table of results appears. If you previously turned on Privacy mode, the student IDs and statistics appears as gray shapes in the table.

4. If Privacy mode is on, click the **Privacy: On** indicator .

The first columns of the table of class results show the student name, ID and average score for all the assessments the student has participated in. The columns that follow show each student's results for every assessment the class has participated in.

To display detailed results for each student

1. Complete the above procedure, and then select the student's row.
The student's information appears in the lower pane.
2. Click the **Performance** tab.

An *Assessment Results over Time* graph appears showing the student's results compared to the class average for all assessments since the first assessment was run.

NOTE

The graph is hidden when Teacher Tools is in Privacy mode.

3. Place your pointer over the graph to display details about the specific assessment.
4. Click the **Results** tab.

A table appears showing detailed information about each assessment the student has participated in, including the date and the score the student achieved. If the student's score is below the passing grade you defined when you created the class, the score appears in red. See *Changing a class's passing grade* on page 30 for information.

CHAPTER 5

Reviewing, printing and exporting assessment results

■ To display class assessment results

1. If a class is currently running, stop it.
2. In Teacher Tools, select the class name in the *Gradebook* area.
The *Teacher Tools* window appears with the *Home* tab selected.
3. Click the **Assessments** tab.

After a short delay, a table of results appears listing all assessments that the class has participated in, including the class average score for each assessment. If the class average score is below the passing grade you defined when you created the class, the score appears in red. See *Changing a class's passing grade* on page 30 for information.

■ To display detailed results for each assessment

1. Complete the previous procedure, and then select the assessment's row.
The lower pane of the window displays the assessment's properties.
2. Click the **Performance** tab.

A *Student Achievement per Question* graph appears showing the student responses to each question.

NOTE

The graph is hidden when Teacher Tools is in Privacy mode.

3. Place your pointer over the graph to display details about the specific questions.
4. Click the **Results** tab.

A table appears showing the mark each student received for the assessment. If the student's score is below the passing grade you defined when you created the class, the mark appears in red.

■ To display and change results for each question in the assessment

1. If a class is currently running, stop it.
2. In Teacher Tools, select the class name in the *Gradebook* area.
The *Teacher Tools* window appears with the *Home* tab selected.
3. Click the **Assessments** tab.

After a short delay, a table of results appears listing all assessments that the class has participated in.

CHAPTER 5

Reviewing, printing and exporting assessment results

4. Select the row for the assessment you want display.
5. Click the **Questions** tab.

A list of the assessment's questions appears showing the student responses to each question.

6. If you want to change an answer to be graded as correct or incorrect, select the question you want to change, and then select or clear the **Correct** checkbox.

The student grades and the class average change.

Flagging results

You can add a blue flag  to a student's results as a visual reminder to follow up for any reason, for example, if a student requires remedial work. You can also clear the blue flag from the student's results.

NOTE

If students are disconnected during an assessment, a *Disconnected Student* icon appears beside their names. To clear this flag, see *Importing assessment results* on page 69.

To add a follow-up flag

1. Start Teacher Tools. See *Starting Teacher Tools* on page 20.
Teacher Tools appears.
2. Select the class the student belongs to in the *Gradebook* class list.
The class information appears.
3. Click the **Students** tab.
4. Select the student's name in the list.
The student's information appears in the lower pane.
5. Click the **Results** tab.
6. Select the assessment result you want to flag in the list.
7. Click the **Set flag** icon  above the results list.
A blue flag appears in the *Mark* column.

■ **To clear a follow-up flag**

1. In the *Results* tab, select the assessment result with the flag you want to clear.
2. Click the **Clear flag** icon  above the results list.
The flag disappears.

Generating student performance reports

You can generate student performance reports at any time after your assessments are complete. You can tailor the reports to include all classes or select classes. You can also create reports for individual students or for all students in the selected classes at one time.

■ **To generate a student performance report**

1. Start Teacher Tools. See *Starting Teacher Tools* on page 20.
Teacher Tools appears.
2. In the *Reports* area, click **Student Performance**.
The *Student Performance Report* window appears.
3. In the *Class* drop-down list, select the class you want a report for.
OR
Select **All classes** for a report on all classes.
4. In the *Student* drop-down list, select the student you want a report on.
OR
Select **All students** for a report on all students.
5. Define the **Report Period** if you want a report for a specific range of dates.
6. In the *Include* drop-down list, select **Selected assessment types** or **All assessment types**.
7. If you chose **Selected assessment types**, select the types you want a report for from the check list that appears.
8. Browse to where you want to save the report file, and then click **Create**.
SMART Response creates one or more reports as PDF files that appear in your default PDF viewer. The files are named using the student name and ID, and the date the files are created.
If you generated one report, the report opens automatically. If you generated multiple reports, the report's folder location appears in Windows Explorer or Mac Finder.

Generating class performance reports

You can generate class performance reports at any time after your assessments are complete. You can tailor the reports to include all classes or select classes. You can also create reports on all assessment types or on specific types of your choice.

■ To generate a class performance report

1. Start Teacher Tools. See *Starting Teacher Tools* on page 20.

Teacher Tools appears.

2. In the *Reports* area, click **Class Performance**.

The *Class Performance Report* window appears.

3. In the *Class* drop-down list, select the class you want a report for.

OR

Select **All classes** for a report on all classes.

4. Define the **Report Period** if you want a report for a specific range of dates.

5. In the *Include* drop-down list, select **Selected assessment types** or **All assessment types**.

6. If you chose **Selected assessment types**, select the types you want a report for from the check list that appears.

7. Browse to where you want to save the report file, and then click **Create**.

SMART Response creates one or more reports as PDF files that appear in your default PDF viewer. The files are named using the class name and ID, and the date the files are created.

If you generated one report, the report opens automatically. If you generated multiple reports, the report's folder location appears in Windows Explorer or Mac Finder.

Printing and exporting questions and results

Using SMART Notebook's *Response* menu, you can create hard copies of questions, handouts and student results. You can also export questions and student results to an Excel spreadsheet, comma separated values (CSV) file or an HTML web page.

Printing from SMART Notebook's Response menu

You can print a variety of information from the *Response* menu in SMART Notebook software. You can create and include header, footer and date information, and select a page range to print.

CHAPTER 5

Reviewing, printing and exporting assessment results

Print option	Description
Thumbnails	On one page, print up to six full-color, reduced images of each SMART Notebook page. You can include page numbers, image borders and page titles.
Handouts	On one page, print up to three full-color, reduced images of each SMART Notebook page, with ruled lines for notes. You can include page numbers, image borders and page titles.
Full page	On one page, print a full-color image of each SMART Notebook question page. You can include page numbers.
Questions	Print several questions on a page. If the question page doesn't have any objects or images, only the text appears. If there are objects on the question page, a full-color thumbnail of the question appears. You can include page numbers.
Results	<p>i NOTE</p> <p>This option is available only after you stop your assessment.</p> <p>Print several questions on a page. If the question page doesn't have any objects or images, only the text appears on the page. If there are objects on the question page, a full-color thumbnail of the question appears. In the <i>Print Preview</i> view, you can click the question to toggle from thumbnail to text-only format.</p> <p>The correct answer and the student's response appear beside each question, and the total score appears at the top of the first page. You can include page numbers.</p> <p>You can print a summary of the results for all students in the class list, or you can print the results for selected students.</p>

■ To print questions or results

Select **Response > Print**, and then select the option you want to print.

OR

For other options, select **Response > Print > More Print Options** to open SMART Response software's print window.

i NOTE

The *Questions and Results* print options are available only if the SMART Notebook file includes SMART Response questions and saved results information. If the assessment is still running, or if it stops before any student answers a question, no results are saved.

CHAPTER 5

Reviewing, printing and exporting assessment results

Exporting results

If you save your SMART Notebook file after you ask questions, or after you run an assessment, you can open the SMART Notebook file at any time to view the results.

You can export the results to an Excel spreadsheet (Windows only), to an HTML page for viewing on a web browser or to a comma separated values (CSV) file that you can import into many spreadsheet and database applications. See *CSV and XLS file formatting* on page 71. You can also export the results to a third-party gradebook in one of the predefined formats, or you can create a custom format.

NOTE

You can export results only after you stop the assessment. If you clear the results after you stop, the results are permanently deleted and you're unable to print or export them. After you save and close the SMART Notebook file, you can open the file and print or export the results.

To export results from Teacher Tools

1. Start Teacher Tools. See *Starting Teacher Tools* on page 20.

Teacher Tools appears.

2. Select **File > Export** from the menu bar.

The *Export* dialog box appears.

3. In the list, select the class with the results you want to export, and then click **Next**.

4. Select the **By student** option if you want to export results for your entire class (the default selection) or for an individual student. If you want to export results for an individual student, also select the student's name from the drop-down list.

OR

Select the **By assessment** option if you want to export the results of a class assessment or all assessments the class has taken.

OR

Select the **To another gradebook format** option if you want to export the results to a third-party gradebook.

NOTE

If you select the CSV file format, you can customize the format to be compatible with your third-party gradebook. SMART Response will save the customized format so that you don't have to customize the format each time you export the results.

CHAPTER 5

Reviewing, printing and exporting assessment results

5. Click **Next**.
6. Select the format you want to export the results in, and then click **Next**.
A *Save As* dialog box appears.
7. Browse to a folder, type a name for the file, and then click **Save**.
The results export and open in your computer's default file viewer.

To export results from SMART Notebook software

1. Stop the assessment if it's still running.
Don't clear the results.
2. In SMART Notebook, select **Response > Export results to > Microsoft Excel**.

NOTE

Exporting to Excel isn't available on Mac computers.

OR

Select **Response > Export results to > Web Page (HTML)**.

OR

Select **Response > Export results to > Comma Separated Values (CSV)**.

A *Save As* dialog box appears.

3. Browse to a folder, type a file name, and then click **Save**.
Either Excel or your default web browser opens, showing the exported file.

Chapter 6

Maintaining SMART Response

IN THIS SECTION

Preventing component damage.....	81
Cleaning the receiver and clickers.....	81
Transporting SMART Response hardware.....	82
Changing clicker batteries.....	82
Resetting clickers.....	83
Receiver indicator lights.....	83
Troubleshooting the receiver.....	84
Resetting the receiver.....	84
Interpreting the receiver indicator lights.....	84
Other troubleshooting tips.....	85

Preventing component damage

CAUTION

- Do not use sharp or pointed objects, such as ballpoint pens or pointers, to press the clicker buttons.
- Do not use abrasive erasers or harsh chemicals to clean the receiver or clickers.
- Avoid setting up and using your system in an area with excessive levels of dust, humidity or smoke.

Cleaning the receiver and clickers

With proper care, your SMART Response hardware will provide years of trouble-free service. Follow these cleaning tips to maintain your SMART Response system:

- Remove dust with a damp cloth before using a cleaner.
- Clean the unit's surface with a household glass cleaner, such as Windex®, daily, weekly or as required.

CHAPTER 6

Maintaining SMART Response

- Do not spray cleaner directly onto the clicker. Instead, spray a small amount of cleaner on a cloth and then gently wipe the clicker.

Transporting SMART Response hardware

If you need to ship your SMART Response hardware, repack it with as much of the original packaging as possible. If you prefer to use your own packaging materials, make sure you adequately protect the product.

Changing clicker batteries

Under normal operating conditions, the clicker batteries can operate for up to 200 days. When replacing them, use fresh batteries of the same type and quality, and change all of them at the same time.

▲ CAUTION

- Do not install batteries with the polarity (+/-) reversed.
- Do not attempt to recharge the batteries.
- Do not dispose of batteries in a fire or incinerator.
- Dispose of batteries according to your region's laws and regulations. If you don't know the applicable rules for your region, consult your battery manufacturer.

■ To change the clicker batteries

1. If the clicker is on, turn it off.
2. Using the included Phillips® screwdriver, remove the screw from the back of the clicker, and then remove the cover.

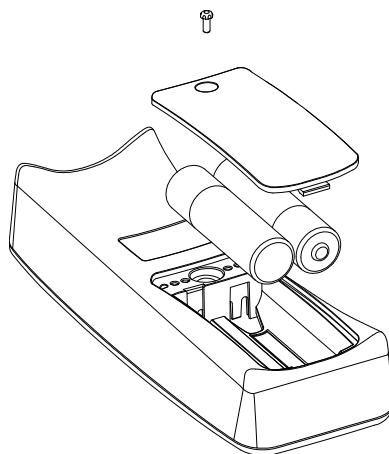

CHAPTER 6

Maintaining SMART Response

3. Remove all of the exhausted batteries, and dispose of them according to local regulations.
4. Insert two new AA batteries.
5. Replace the cover and screw.

Resetting clickers

If your clicker isn't operating as expected, you might need to reset it. Perform the following steps to reset it.

■ To reset the clicker

1. If the clicker is on, turn it off.
2. Using the included Phillips screwdriver, remove the screw from the back of the clicker, and then remove the cover.
3. Remove the batteries.
4. Press and hold the **Power** button for at least five seconds.
5. Replace the batteries.
6. Replace the cover and screw.

Receiver indicator lights

Receivers have the following indicator lights:

- The Ready light
- The Transmit light
- The Receive light

The Ready light is in the upper right corner of the receiver. The Ready light indicates the operational states of the receiver module. The Transmit and Receive lights flash green indicating transmit and receive activity between the receiver and the clickers.

The following table shows the Ready light's normal states. If the light's behavior doesn't match a state listed here, refer to *Troubleshooting the receiver* on next page.

Ready light state	Description
Off	The receiver is disconnected from the computer.

Ready light state	Description
Solid red	The receiver has power, but either it isn't communicating with the computer or no class is started.
Solid green	The receiver is receiving power and communicating successfully with SMART Response software.

Troubleshooting the receiver

CAUTION

Do not open the receiver or the clicker units to attempt repairs. Refer all service inquiries to authorized SMART service personnel.

Resetting the receiver

If your SMART Response software behaves erratically (possibly because of a static discharge or power fade), you might be able to restore normal operation by resetting the receiver.

Reset the receiver completely by disconnecting and then reconnecting the USB cable.

Interpreting the receiver indicator lights

If you experience a problem with your receiver, you can use its indicator lights to troubleshoot it.

Ready light	Transmit light	Receive light	Receiver state
Red, green, yellow	Green	Green	Receiver is starting up. Lights flash in sequence.
Flashing green	Off	Off	Receiver is scanning radio channels.
Flashing green	Any state	Any state	Receiver is accepting commands from the computer.
Green	Constant flashing	Flashes when it receives data from a clicker	Receiver has power and is communicating with the computer, but it isn't receiving commands.
Yellow	Off	Off	Receiver has power, but communication circuits have failed.

CHAPTER 6

Maintaining SMART Response

Ready light	Transmit light	Receive light	Receiver state
Flashing red	Flashing	Flashing	Manufacturing tests running, and receiver isn't operational. All lights flash together.
Flashing yellow	Any state	Any state	Receiver software checksum failed.
Flashing yellow	Flashing	Flashing	Receiver software failure.

Other troubleshooting tips

Symptom/observation	Action/remedy
When you export SMART Response question set results from a SMART Notebook file using the CSV command, fractions change to dates.	In your exported results, change the exported dates to fractions, add a space before each fraction and convert the month to its numerical value. The converted month is the fraction's numerator, and the day is the denominator.
Your computer doesn't recognize SMART Response, and the receiver's Status LED light remains solid red.	Remove the SMART Response hardware drivers on your computer, and then reconnect the receiver following the instructions in <i>The SMART Response System Receiver Doesn't Work</i> (smarttech.com/kb/115401).
Responses from students don't appear in SMART Notebook reports.	Wait at least 10 seconds after the last student responds before you stop a question set.
Additional SMART Response receivers don't connect to the network when you install more than one receiver on your computer.	Disconnect the additional receiver's USB plug to resume normal operation. Disconnect and reconnect the first receiver's USB plug if it doesn't work, or if the Status light turns red. i NOTE Installing more than one receiver affects your computer's performance and doesn't increase your reception.
During the installation of a SMART software product on the Windows operating system, a dialog box appears informing you that the installation was interrupted.	To prevent interruptions, restart the computer and follow the procedure outlined in <i>The Windows XP SP2 Operating System Interrupts the Installation of a SMART Software Product</i> (smarttech.com/kb/077681).

Appendix A

Hardware environmental compliance

SMART Technologies supports global efforts to ensure that electronic equipment is manufactured, sold and disposed of in a safe and environmentally friendly manner.

Waste Electrical and Electronic Equipment Regulations (WEEE directive)

Waste Electrical and Electronic Equipment regulations apply to all electrical and electronic equipment sold within the European Union.

When you dispose of any electrical or electronic equipment, including SMART Technologies products, we strongly encourage you to properly recycle the electronic product when it has reached end of its life. If you require further information, please contact your reseller or SMART Technologies for information on which recycling agency to contact.

Restriction of Certain Hazardous Substances (RoHS directive)

This product meets the requirements of the European Union's Restriction of Certain Hazardous Substances (RoHS) Directive 2002/95/EC.

Consequently, this product also complies with other regulations that have arisen in various geographical areas, and that reference the European Union's RoHS directive.

Batteries

Batteries are regulated in many countries. Check with your reseller to find out how to recycle used batteries.

There are special regulations that must be met when shipping a product that has a lithium ion battery packaged with the product or shipping a lithium ion battery. When returning a SMART Technologies

APPENDIX A

Hardware environmental compliance

product which contains a lithium ion battery or returning a lithium ion battery, call SMART Technologies RMA for information on these special shipping regulations:

- 1.866.518.6791, Option 4 (U.S./Canada)
- 1.403.228.5940 (all other countries)

Packaging

Many countries have regulations restricting the use of certain heavy metals in product packaging. The packaging used by SMART Technologies to ship products complies with applicable packaging laws.

Covered electronic devices

Many U.S. states classify monitors as covered electronic devices and regulate their disposal. Applicable SMART Technologies products meet the requirements of the covered electronic devices regulations.

China's Electronic Information Products regulations

China regulates products that are classified as EIP (Electronic Information Products). SMART Technologies products fall under this classification and meet the requirements for China's EIP regulations.

U.S. Consumer Product Safety Improvement Act

The United States has enacted the *Consumer Product Safety Improvement Act* which limits the lead (Pb) content in products used by children. SMART Technologies is committed to complying with this initiative.

California Air Resources Board – Airborne Toxic Control Measure

California has enacted a law to restrict the emissions of formaldehyde from composite wood products. The SMART Technologies products that contain composite wood products are compliant to this regulation.

APPENDIX A

Hardware environmental compliance

Restriction of Certain Chemicals (REACH directive)

The European Union has enacted the EU REACH Directive which restricts the use of certain chemicals in products. SMART Technologies is committed to complying with this initiative.

Appendix B

Customer support

Online information and support

Visit www.smarttech.com/support to view and download user's guides, how-to and troubleshooting articles, software and more.

Training

Visit www.smarttech.com/trainingcenter for training materials and information about our training services.

Technical support

If you experience difficulty with your SMART product, please contact your local reseller before contacting SMART Support. Your local reseller can resolve most issues without delay.

i NOTE

To locate your local reseller, visit www.smarttech.com/wheretobuy.

All SMART products include online, telephone, fax and e-mail support:

Online	www.smarttech.com/contactsupport
Telephone	+1.403.228.5940 or Toll Free 1.866.518.6791 (U.S./Canada) (Monday to Friday, 5 a.m. – 6 p.m. Mountain Time)
Fax	+1.403.806.1256
E-mail	support@smarttech.com

Shipping and repair status

Contact SMART's Return of Merchandise Authorization (RMA) group, Option 4, +1.866.518.6791, for shipping damage, missing part and repair status issues.

APPENDIX B

Customer support

General inquiries

Address	SMART Technologies 3636 Research Road NW Calgary, AB T2L 1Y1 CANADA
Switchboard	+1.403.228.5940 or Toll Free 1.866.518.6791 (U.S./Canada)
Fax	+1.403.228.2500
E-mail	info@smarttech.com

Warranty

Product warranty is governed by the terms and conditions of SMART's "Limited Equipment Warranty" that shipped with the SMART product at the time of purchase.

Registration

To help us serve you, register online at www.smarttech.com/registration.

SMARTTM

Toll Free 1.866.518.6791 (U.S./Canada)
or +1.403.228.5940
www.smarttech.com