

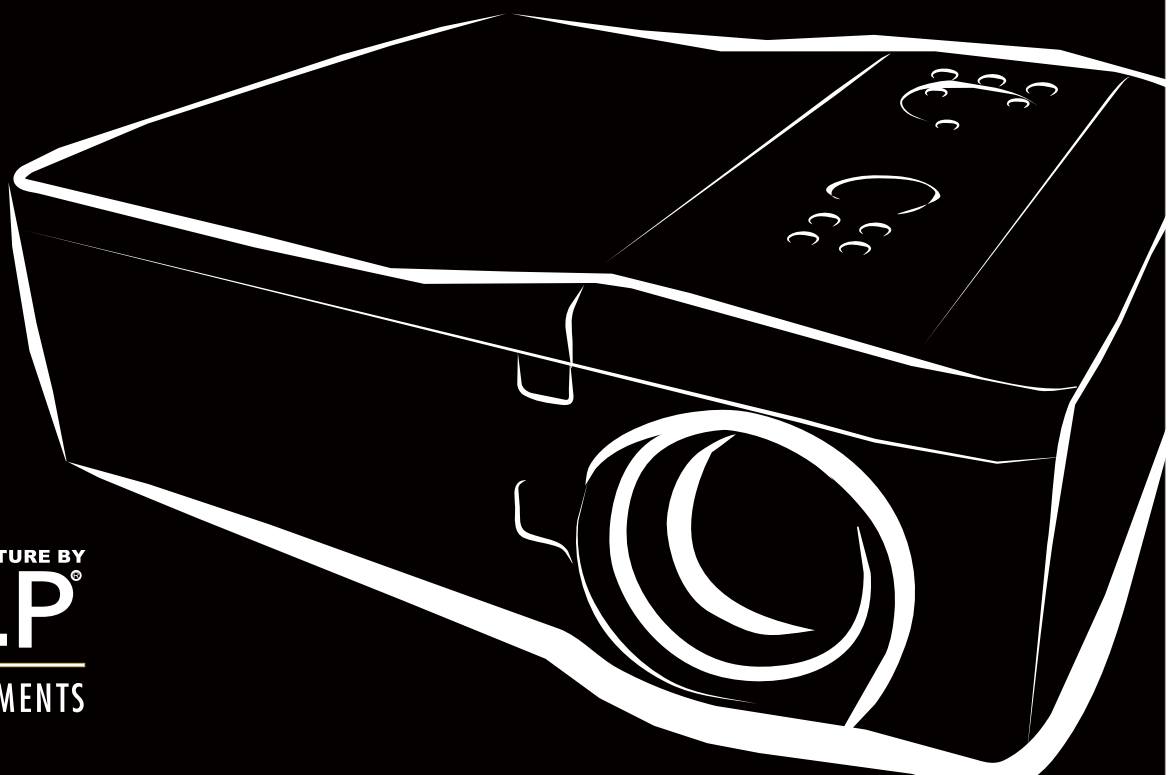

User's Manual

DU6675



PICTURE BY
DLP[®]
TEXAS INSTRUMENTS

Table of Contents

Copyright	4
Important Safety Guidelines	5
FCC NOTIFICATION.....	5
CE NOTIFICATION.....	5
NOTIFICATION (Canada).....	5
AC Power Cord for North/Middle/South and Taiwan.....	5
Disposal of Old Electric and Electronic Equipment.....	6
Important Recycling Instructions.....	6
Installation and Use Notice.....	6
Introduction	7
Product Features.....	7
Packing Checklist.....	8
Projector Overview.....	9
Front-right View.....	9
Rear-right View.....	9
Bottom View.....	10
Control Panel.....	11
Terminal Panel Features.....	12
Remote Control.....	13
Installation and Setup	14
Precautions for Installation.....	14
Caution for Ceiling Mounting Installation.....	15
Upward or Downward Installation.....	16
Installing or Removing the Optional Lens.....	17
Installing the Optional Color Wheel.....	18
Remote Control and Operation Range.....	19
Turning On the Projector.....	20
Turning Off the Projector.....	21
Adjusting Projected Image Position.....	22
Adjusting the Focus and Zoom.....	23
Making Connections.....	24
Connecting to the Screen Trigger.....	26
Connecting to External HDBaseT Transmitter.....	27
CONVENIENT FEATURES	28
Changing the OSD Language.....	28
Selecting an Input Source.....	28
Changing Lamp Power.....	29
Freezing a Picture.....	29
Blanking the Image.....	29
Correcting Keystone Distortion.....	30
Preventing the Unauthorized Use of the Projector.....	31
Using the Control Panel Lock.....	31
Using the Security Lock.....	31
Using the Physical Lock.....	32
Getting Information.....	32

Using On-Screen Display.....33

- Navigating the OSD33
- Menu Tree.....34
- OSD Operation - PICTURE37
- OSD Operation - SIGNAL40
- OSD Operation - SETUP41
- OSD Operation - INSTALLATION45
- OSD Operation - SERVICE.....48

Maintenance.....49

- Replacing the lamp49
- Replacing the Lamp50
- Cleaning the projector.....51

Specification53

Product Dimensions.....54

Supported Signal Input Timing55

Configurations of Terminals.....56

DU6675 Lens Series58

Troubleshooting59

- Indicator Messages.....59
- Common Problems and Solutions60

About the Vivitek Support62

Copyright

Copyright

The User's Manual (including all pictures, illustrations and software) is protected by the international copyright right law. All rights are reserved. No duplication of the manual or any content included in the manual is allowed without the written consent of the manufacturer. Vivitek is the trademark of Vivitek Corporation. ©All rights reserved. 2015

Disclaimer

The information in the manual is subject to change without notice.

The manufacturer does not provide any statement or warranty of the contents in the manual and clearly give up the implied warranties of merchantability and of fitness for a particular purpose. The manufacturer reserves the rights to modify the publication and change the contents of the materials at any time without notice to any person.

About the Manual

The manual describes how to install and use the DLP projector and is applicable to the end-user. Relevant information (such as illustrations and descriptions) is put on the same page as possible as we can. The format, easy for printing, is convenient for reading and paper-saving which is beneficial to environmental protection. It is suggested printing the page you need.

Important Safety Guidelines

Thank you for purchasing the high quality product!
Read the Manual carefully to obtain the best performance. The Manual provides instructions to use the menu and implement operation.

FCC NOTIFICATION

This device complies with part 15 of the FCC Rules. Operation is subject to the following two conditions: (1) This device may not cause harmful interference, and (2) this device must accept any interference received, including interference that may cause undesired operation.

FCC Warning!

This equipment has been tested and found to comply with the limits for a Class A digital device, pursuant to part 15 of the FCC Rules. These limits are designed to provide reasonable protection against harmful interference when the equipment is operated in a commercial environment. This equipment generates, uses, and can radiate radio frequency energy and, if not installed and used in accordance with the instruction manual, may cause harmful interference to radio communications. Operation of this equipment in a residential area is likely to cause harmful interference in which case the user will be required to correct the interference at his own expense.

CE NOTIFICATION

This is a class A product. In a domestic environment this product may cause radio interference in which case the user may be required to take adequate measures.

NOTIFICATION (Canada)

This class A digital apparatus complies with Canadian ICES-003.

AC Power Cord for North/Middle/South and Taiwan

AC Power Cord used in the United States and Canada is listed by the Underwriters Laboratories (UL) and certified by the Canadian Standard Association (CSA).

AC Power Cord has a grounding-type AC line plug. This is a safety feature to be sure that the plug will fit into the power outlet. Do not try to defeat the grounding plug. Should you be unable to insert the plug into the outlet, contact your technical personnel.

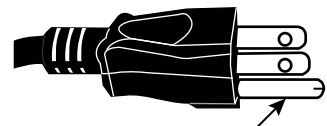

Disposal of Old Electric and Electronic Equipment

The symbol on your product or the package represents that the product should not be treated as the normal household waste when discarded but should be carried to the recycling location of the waste electric and electronic equipment. The consequence on the environment and human health due to the incorrect disposal of the product can be prevented if it can be ensured that the product is properly discarded. Material recycling is helpful to the protection of natural resources. The symbol is only valid in European Union. If you want to discard electrical and electronic equipment, contact the governmental authorities or your dealer for the correct method of disposal.



Important Recycling Instructions

The lamp of the product contains mercury. The product may contain other electronic wastes and may pose risk if not discarded properly. Abide by the local, state/provincial or federal laws of recycling or discarding.

For more information, please visit the website and contact Electronic Industries Alliance (EIA) on WWW.EIAE.ORG. Please visit WWW.LAMPRECYCLE.ORG for the specific disposal information of lamps. 

Installation and Use Notice

1. Read and keep the description properly.
2. Pay attention to all warnings.
3. Follow all guidelines and descriptions.
4. Do not use the equipment near water.
5. Do not install the equipment near the thermal source, such as the heater, radiator, furnace or other equipment that will generate heat (including the amplifier).
6. Use dry clothes to clean only.
7. Do not obstruct any vent. Carry out installation according to the guidelines of the Manufacturer.
8. Do not destroy the safety protection function of polarized or grounding plugs. A polarized plug has one wide and one narrow blade. The grounding plug has two blades and one grounding blade. The wide blade or grounding blade is provided for the safety concerns. If the plug provided does not match the outlet, contact the electrician to change the old outlet.
9. Prevent the power cord from being treaded or pressed, especially the power cord on the plug, outlet and the connection between the power cord and the equipment.
10. Only use the connectors/accessories designated by the Manufacturer.
11. Be careful of moving the trolley/equipment and avoid being hurt due to turning-over when using the trolley.
12. Unplug the power cord of the equipment if there is a thunderstorm or the equipment will not be used for a long time.
13. The authorized maintenance personnel is responsible for all maintenance work. The equipment should be repaired if damaged in any means. (For example, the power cord or outlet is damaged. Liquids splash to the equipment or foreign objects fall into the equipment. The equipment is exposed to rain or humidity. The equipment cannot work functionally or falls.)
14. The +12V trigger only outputs 12V DC trigger signal. Do not connect to other power input or output. Otherwise, the equipment may be damaged.
15. The packaging materials should be kept properly for the use of transportation.
16. Do not look straight at the lens when the projector is running.

Introduction

The User's Manual describes the installation, setup and operation of the DU6675 projector and provides assistance to the installation personnel and the end-user to fully develop the performance of the projector. Vivitek has made every efforts to ensure that the information in the Manual is correct at the time of printing. The contents may be frequently updated due to the continuously product improvement and customer feedback.

You can find the latest version of the Manual and the manual of other Vivitek products on www.vivitekcorp.com.

Product Features

Vivitek DU6675 has the cutting-edge technique and creative dual-lamp optical engine to provide the native high resolution as well as clear, brilliant and vivid pictures.

Main Characteristics and Advantages of the Product Series:

- The DLP system with the high performance digital micromirror device (DMD) in conjunction with the advanced thermal management technology provide the excellent projecting performance and reliability.
- The advanced dual-lamp optical engine as well as the single-lamp, dual-lamp, normal, energy-saving and Custom Lamp Power mode offer the convenience for installation. The power of lamps can be adjusted via Custom Lamp Power to make it easier for the installation personnel to fine-tune the edge blending brightness for multi-projectors application.
- With the lamp switching feature, the projector can automatically select the lamps less used when turned on.
- The projector has the replaceable color wheel and smart color wheel detection, can automatically detect and switch the parameter of corresponding color wheels and can be used in conjunction with the color wheel of high brightness or beautiful hues. It is applicable to the single projector.
- The interchangeable lens design allows the user to easily and quickly change the suitable lens by pressing the Lens Release button.
- With the complete series of motorized projection lenses, the horizontal shift, focusing and zooming of lenses can be electrically controlled. The throw ratio ranges from 0.7:1 to 8.5:1 and is suitable to be used in most applications.
- The high performance video processor can be used in progressive and interlaced scanning of the video inputs and video denoising.
- The complete input terminal support many input signals, such as HDMI, DVI-D, HDBase T/LAN, VGA, RGBHV, YPbPr, VIDEO and S-VIDEO, etc.
- With the built-in HDBase T signal reception, HDBase T transmitter can send high quality video and control signals through the single RJ45 cable.
- Many 3D display format is supported, such as Frame Sequential, Top/Bottom, Side by Side and Frame Packing.
- The synchronization of DLP Link and 3D IR are supported.
- With the high efficient power switch, the power consumption less than 0.5W at the standby mode.

Packing Checklist

The following items are included in the packaging box of the DU6675 projector. If any loss or damage to any item, contact your dealer or the Vivitek customer service center.

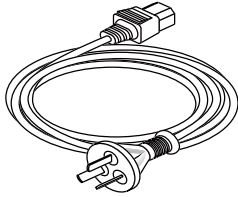

AC power cord
(For China)

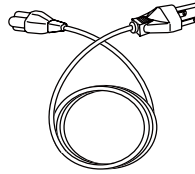

AC power cord
(For US)

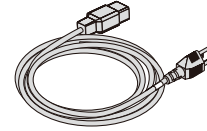

AC power cord
(For EU)

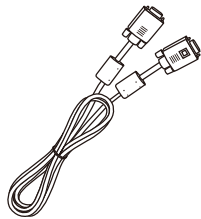

VGA signal cable

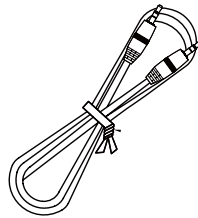

Cable of the wired
remote control

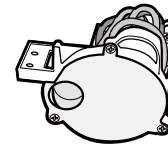

Color-optimized
color wheel



IR remote control

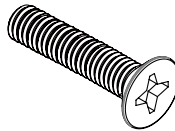

Anti-theft screw
for Lens installation
(M4)



User's manual disc

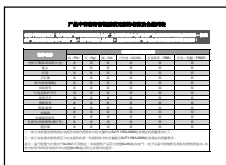

RoHS card (China)



Qualification
certificate
(China)

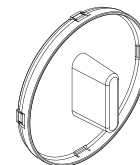

Lens hole cap
(Installed)

Projector Overview

Front-right View

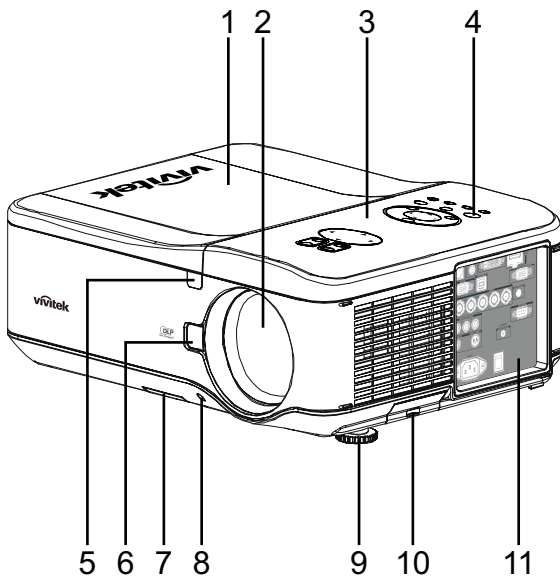

1. **Lamp Cover**
Remove cover to replace lamp or color wheel.
2. **Lens Hood**
Remove lens cap before use.
3. **Control Panel**
Press the button to operate the OSD menu or adjust the lens settings, refer to OSD controls.
4. **LED Indicator**
Displays current projector status such as power, temperature and lamp.
5. **Front IR Receiver**
Receives for IR signals from remote control.
6. **Lens Release Button**
Press the Lens Release button before removing the lens.
7. **Intake Vent**
Lamp cooling vent – do not obstruct.
8. **Anti-thief Screw hole**
The anti-thief screw can be fasten to prevent Lens removing.
9. **Height Adjuster**
Adjust level of projector.
10. **Intake Vent / filter**
The fans pull cool air to the projector for system cooling.
11. **I/O Connector Panel**
Connect to various input, control or output terminals to the projector.

Rear-right View

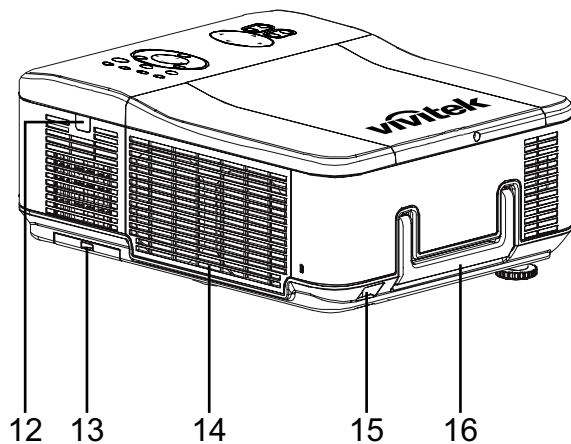

12. **Rear IR Receiver**
Receives for IR signals from remote control.
13. **Rear Intake Vent / filter**
Rear cooling intake – do not obstruct.
14. **Kensington Lock**
Attach the projector to a permanent object with the Kensington slot and a security cable.
15. **Security Chain Lock**
Attach the projector to a permanent object using a security cable.
16. **Carrying Handle**
Pull up the handle when carrying the projector.

Important:

Grill openings on the projector allow for good air circulation, which keeps the projector lamp cool. Do not obstruct any of the grill openings

Bottom View

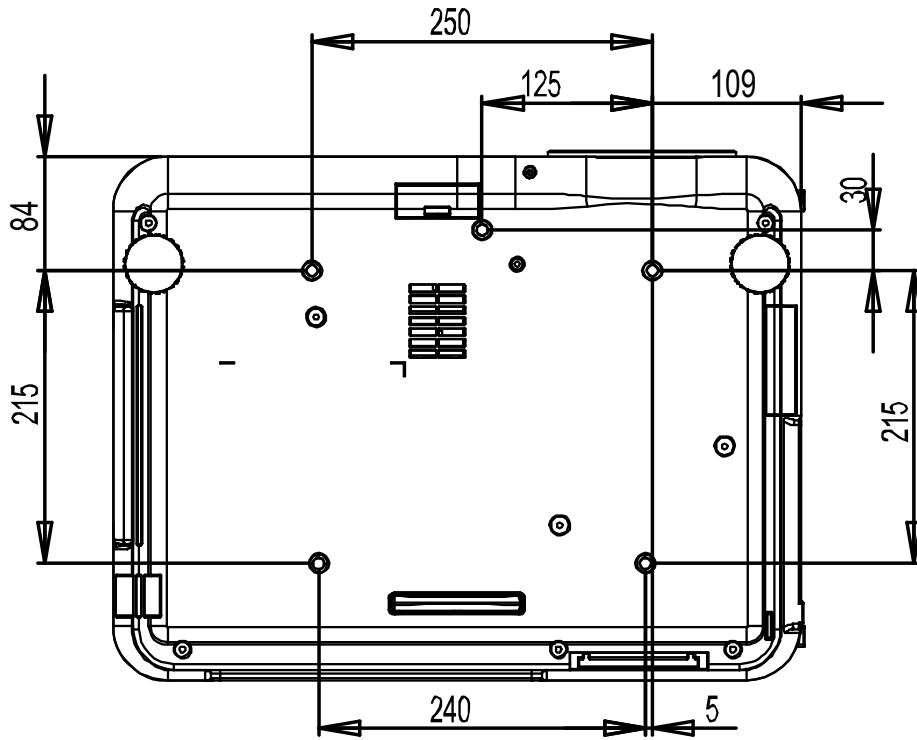

Control Panel

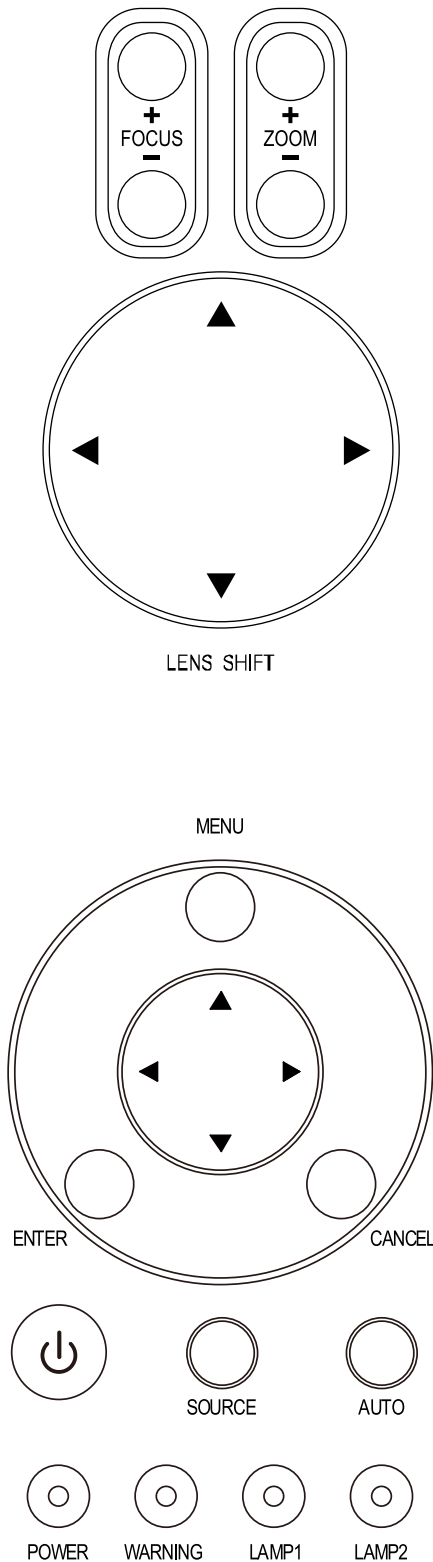

Zoom

Increase or decrease image size.

Focus

Focus the projected image.

Up/Down/Left/Right Cursor

Use the bottom to move the projected image up, down, left or right.

MENU

Press the button to display OSD or exit the OSD menu.

Up/Down/Left/Right Cursor

Use the buttons to navigate the OSD or select the OSD option.

ENTER

Press the button to select or change settings in the OSD.

CANCEL

Exit the OSD menu.

Power

Press the button to turn the projector on (main power switch must be turned on first) or press to place the projector at standby mode.

SOURCE

Select the input source.

AUTO

Auto Sync to optimize image size, position, and resolution.

Terminal Panel Features

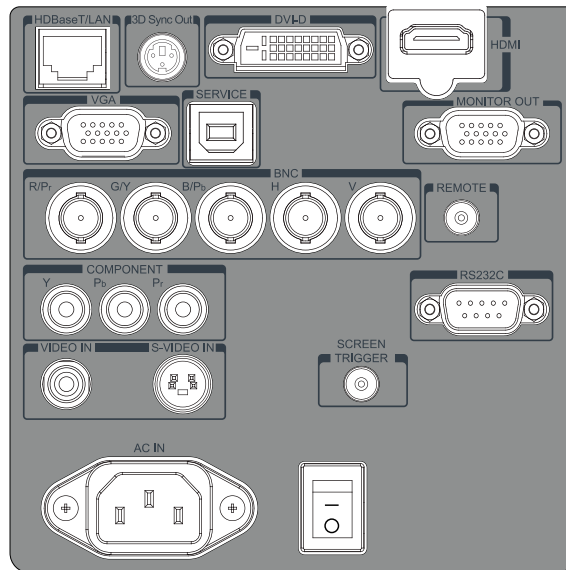

LAN/HDBaseT

Connect a LAN cable (Cat5/Cat6, not supplied) from a computer, network device, or HDBaseT transmitter.

DVI-D

Connect the DVI-D cable (not supplied) from a DVI-D output device.

HDMI

Connect the HDMI cable from a computer or device.

VGA In

Connect a VGA cable (supplied) from a computer.

Service

For service personnel only.

Monitor Out

Connect to a monitor to display the projected content.

BNC (R/P, G/Y, B/Pb, H, V)

Connect RGBHV or Component signal from computer or component video enabled device.

Remote

Connect the remote to the projector.

Note for Screen Trigger:

- When the projector is turned on, a control signal (DC 12V) outputs from this terminal.
- Screen controllers are supplied and supported by screen manufacturers.

COMPONENT

Connect a component video cable from a video device to the RCA jacks.

Video In

Connect a composite video cable (not supplied) from a video device to the yellow RCA jack.

S-Video

Connect a commercially available S-video cable from a video device.

Screen Trigger

When connected to the screen through a commercially available cable, the screen deploys automatically on start up of the projector. The screen retracts when the projector is powered off (see notes below).

AC In

Connect the supplied power cable to AC outlet.

Power Switch

Turn on/off AC power of the projector.

Remote Control

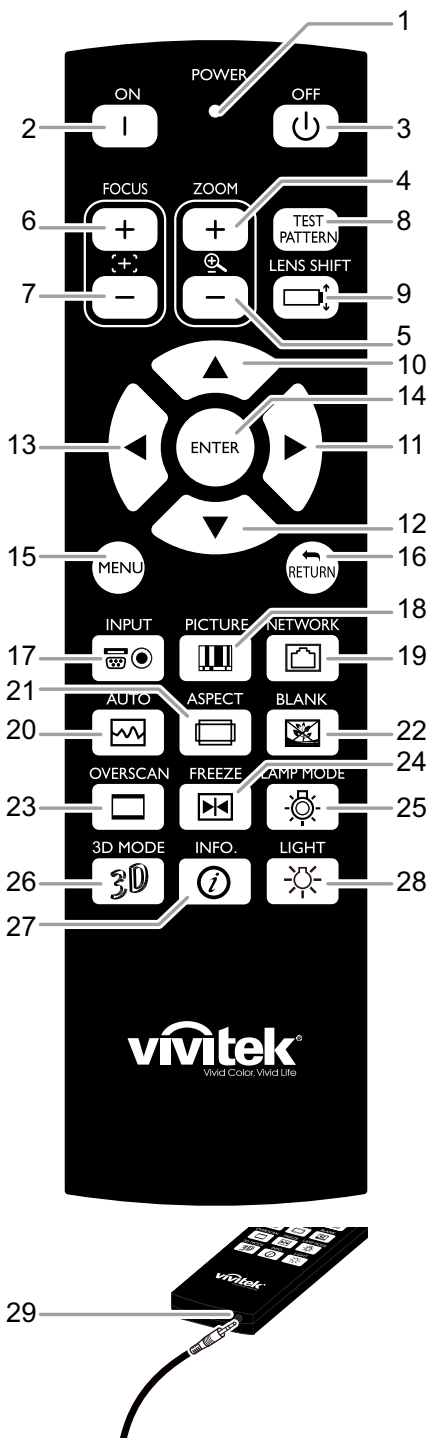

	Label	Description
1	Status LED	Lights when the remote control is used
2	ON	Turn the projector on at standby mode
3	OFF	Turn the projector off (standby mode)
4	ZOOM +	Increase the projection image size
5	ZOOM -	Reduce the projection image size
6	FOCUS+	Focus the projection image
7	FOCUS-	Focus the projection image
8	TEST PATTERN	Display the Test Pattern menu for selection
9	LENS SHIFT	Adjust lens shift range
10	UP	Move OSD cursor up
11	RIGHT	Move OSD cursor right or enter submenu
12	DOWN	Move OSD cursor down
13	LEFT	Move OSD cursor right or enter submenu
14	ENTER	Freeze/unfreezes the projected image picture
15	MENU	Display OSD main menu
16	RETURN	Return to last OSD page or exit menu
17	INPUT	Select the input source
18	PICTURE	Display picture menu
19	NETWORK	Display network setting menu
20	AUTO	Auto adjustment for phase, tracking, size, position
21	ASPECT	Set up aspect ratio of the projected image
22	BLANK	Blank the image or press again to display the imaged
23	OVERSCAN	Enable or disable the overscan function
24	FREEZE	Freeze/unfreeze the projected image
25	LAMP MODE	Display the Lamp Control menu
26	3D MODE	Display the 3D Mode menu
27	INFO.	Display the Information menu
28	LIGHT	Illuminates the buttons on the remote control for 10 sec.
29	Wire remote jack	Connect to WIRED REMOTE terminal on the projector

Installation and Setup

Precautions for Installation

Caution:

Ceiling installation must be done by a qualified professional. Contact your dealer for more information. It is not recommended you install the projector by yourself.

Place the projector in a horizontal position.

The tilt angle of the projector should not exceed 15 degrees, nor should the projector be installed in any way other than the desktop and ceiling mount, otherwise lamp life could decrease dramatically, and may lead to other unpredictable damages.

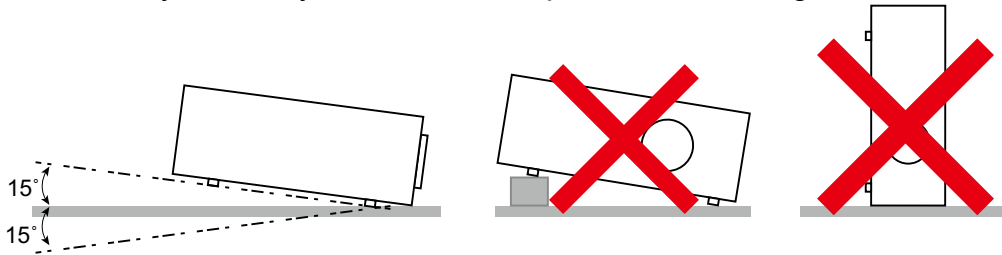

Allow at least 50 cm clearance around the exhaust vent.

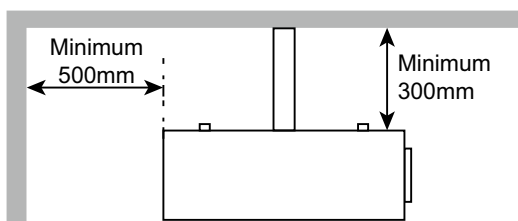
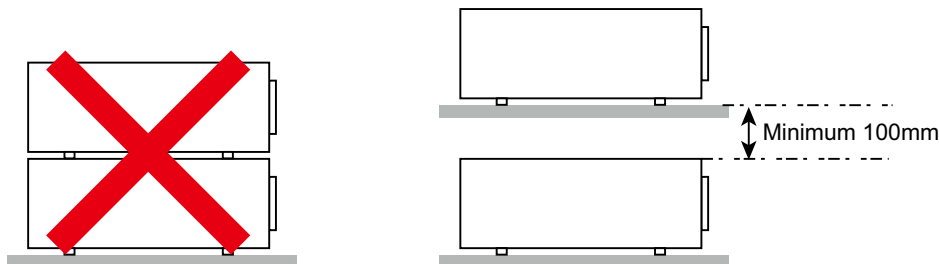
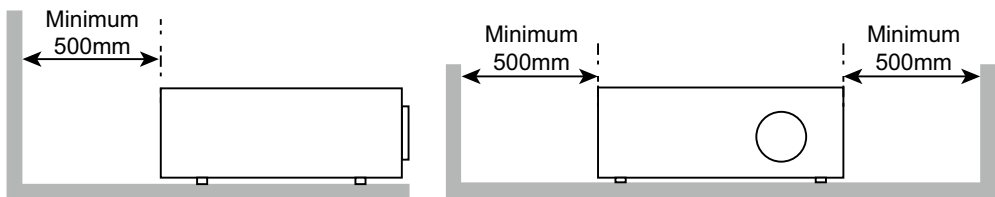

- Ensure that the intake vents do not recycle hot air from the exhaust vent.
- When operating the projector in an enclosed space, ensure that the surrounding air temperature within the enclosure does not exceed operation temperature while the projector is running, and the air intake and exhaust vents are unobstructed.
- All added enclosures should pass a certified thermal evaluation to ensure that the projector does not recycle exhaust air, as this may cause the device to shutdown even if the enclosure temperature is within the acceptable operation temperature range.

Caution for Ceiling Mounting Installation

When installing the projector other than desktop front or rear installation, please read below notice carefully. mounting installation.

For ceiling mounting installation, please use UL Listed ceiling mounts and M4 screws, maximum depth of screw: 12 mm, the distance from wall to projector must be kept 30cm at least for proper ventilation.

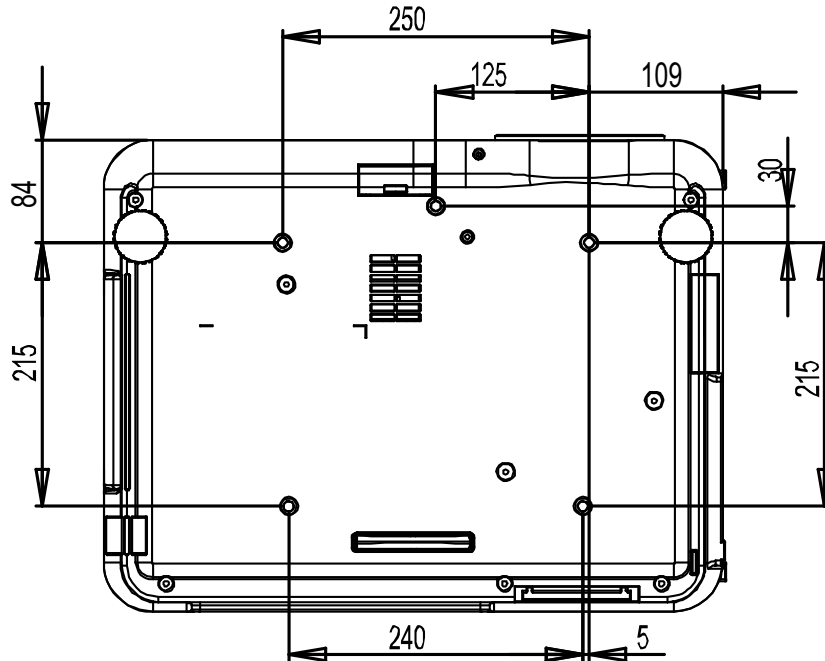

Projector Installation

The high quality display effect can be guaranteed only when the projector is correctly installed. Generally, the light source facing the screen should be reduced or eliminated as much as possible. The contrast of the image will be obviously reduced if the light directly shines on the screen, such as the beam from windows or the searchlight cast on the image. The image may become faded and not bright. The available installation options as below.

Desktop Front

Install the projector on the table and project the image forward.

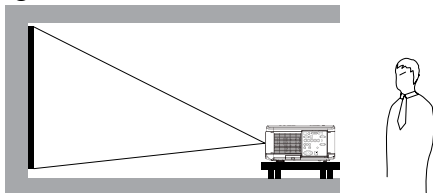

Ceiling Front

Mounting the projector on the ceiling and project the image forward.

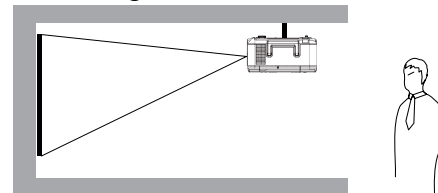

Desktop Rear

Install the projector on the table and project the image from rear.

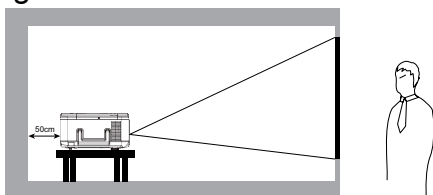

Ceiling Rear

Mounting the projector on the ceiling and project the image from rear.

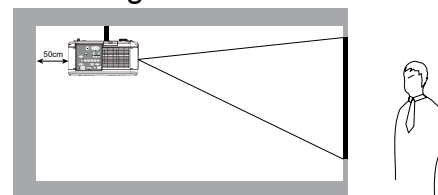

Upward or Downward Installation

The projector can be installed in addition to the desktop and installed in the ceiling, but also can be mounted up or down for upward or downward projection. When the projector is projected upward or downward, please set Projection Mode (SETUP->Projection Mode) to Upward Front or Downward Front. Refer to the following illustration to set Projection Mode.

Please note that lamp life may be reduced, contact your local dealer for more information

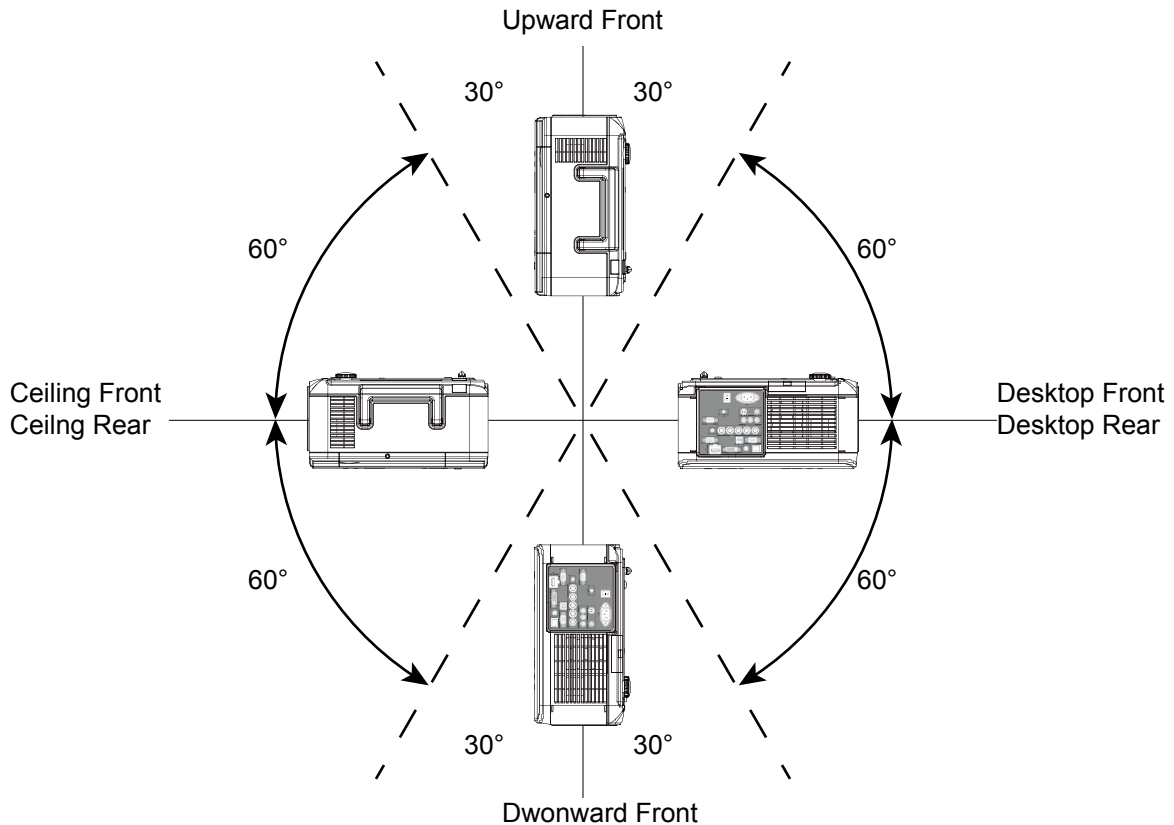

Note:

- In addition to flip the projected image, the cooling fan will also be adjusted to the corresponding speed in order to maintain proper operating temperature of the projector.
- Incorrect Projection Mode setting may affect hot air exhausting from the projector the heat, high temperature may cause the projector goes into system protection, component damage or lamp damage.
- Brightness decay of upward or downward installation is faster than desktop or ceiling installation. Refer to laboratory test results, Lamp life may be reduced to 50-75% of the life which the projector is installed by Desktop or Ceiling installation. Recommend to regularly check the lamps and the brightness of projected image, please consult your local dealer before the projector is installed upward or downward.

Installing or Removing the Optional Lens

Caution:

Do not shake or place excessive pressure on the projector or the lens components as the projector and lens components contain precision parts.

- When shipping the projector with the optional lens, remove the optional lens before shipping the projector. The lens and the lens shift mechanism may encounter damage caused by improper handling during transportation.
- Before removing or installing the lens, be sure to turn off the projector, wait until the cooling fans stop, and turn off the main power switch.
- Do not touch the lens surface when removing or installing the lens.
- Keep fingerprints, dust or oil off the lens surface. Do not scratch the lens surface.
- Work on a level surface with a soft cloth under it to avoid scratching.
- If you remove and store the lens, attach the lens cap to the projector to keep off dust and dirt.

Removing the Existing Lens

1. Press and hold Lens Release button, rotate the lens counterclockwise. The existing lens will be disengaged.

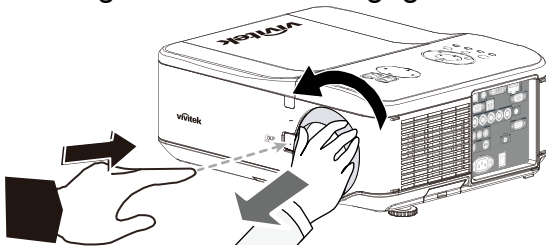

2. Pull out the existing lens slowly.

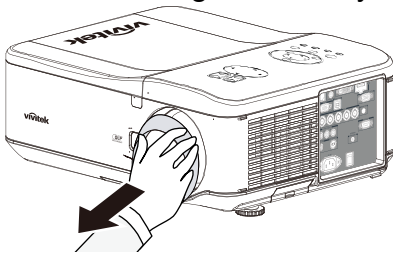

Installing New Lens.

1. Align the "▲" symbol on the lens label with the " * " symbol on the top of the body (align to the center of the lens hole) and pull in the lens.

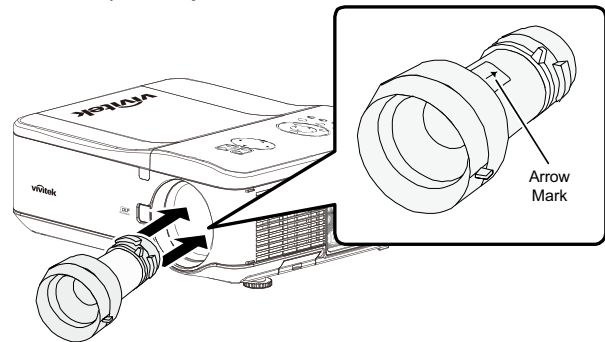

2. Make sure the lens is pushed into the holder and turn it clockwise to the "Lock" position. When turning the lens, the "Click" sounds twice to indicate that the lens is completely fixed.

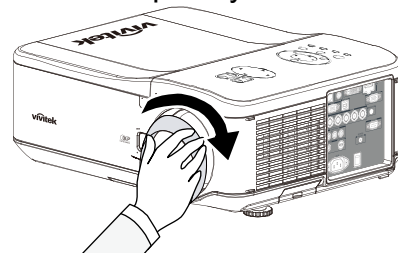

3. Check if the lens is fixed successfully by pulling the lens out of the holder gently.

Caution:

- When installing the lens into the projector, be sure to remove the lens cap from the back of the optional lens before installing the optional lens into the projector. Failure to do so will cause damage to the projector.
- Be sure to detach anti-theft screw before removing the projection lens from the projector.

Installing the Optional Color Wheel

The projector comes with a four-segment color wheel installed. An additional six-segment color wheel is an optional. To replace the color wheel (located under the lamp cover adjacent to lamp 1) refer to the following guide.

Note:

- Wait until the lamp house and the color wheel cool off
- Only use the projector on a solid, level surface. Serious injury and damage can occur if the projector is dropped.

Removing the existing color wheel

1. Remove the screws (A) on the lamp cover. Lift the lamp cover in the direction of the arrow (B).

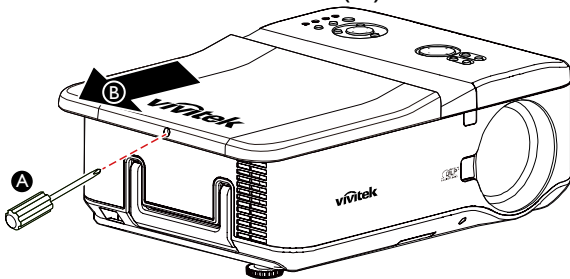

2. Unscrew the retaining screws (x 4) on the color wheel.

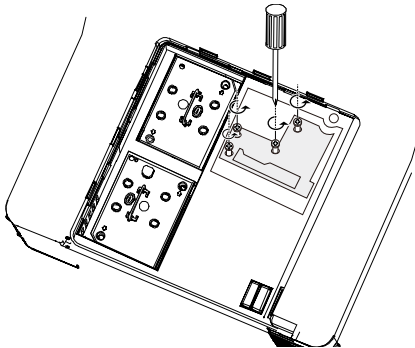

3. Lift the color wheel in the direction shown.

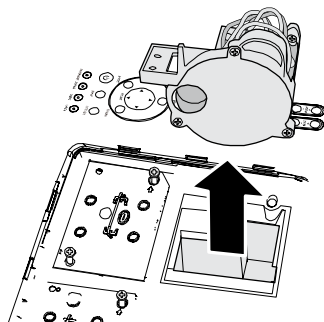

Installing the new color wheel

1. Insert the new color wheel.

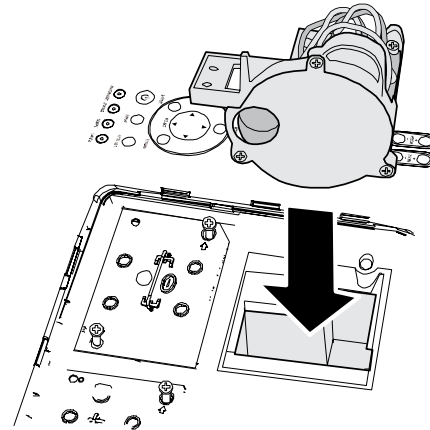

2. Tighten the 4 screws on the color wheel.

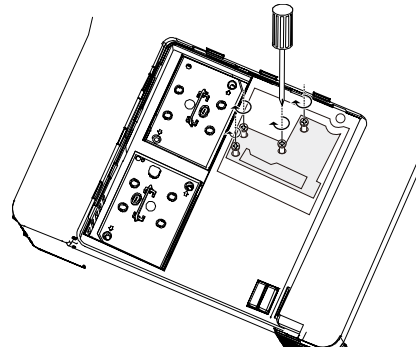

3. Place the color wheel (A) and tighten the screw on the lamp cover as below illustration (B).

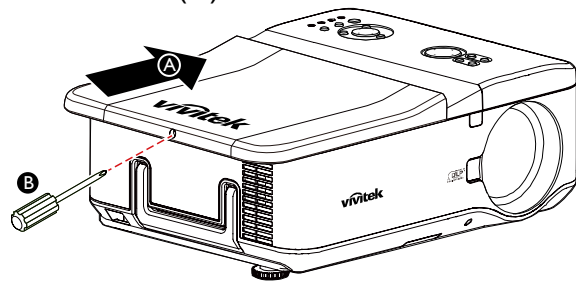

Note:

- Keep the unused color wheel in the zipper bag in which the 6-segment color wheel was packaged. This bag prevents dust from falling or collecting on the color wheel.

Remote Control and Operation Range

Inserting the Remote Control Batteries

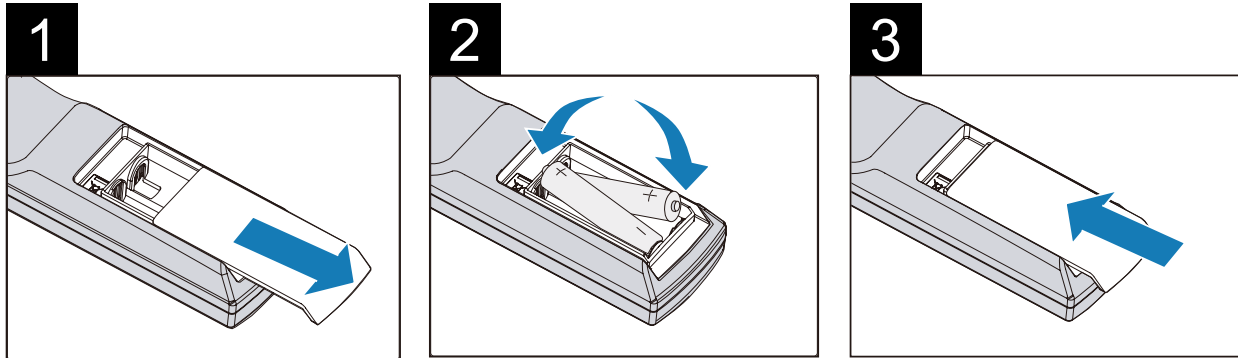

1. Remove the battery compartment cover by sliding the cover in the direction of the arrow.
2. Place two AA batteries with the correct polarity.
3. Slide on the cover as the arrow in the illustration.

Battery installation instructions

- Make sure the battery is installed with the correct polarity.
- Do not use the old and new batteries or the batteries of different types together.
- Remove the battery if the remote control may not be used for a long time to prevent the damage caused by leaks.

Remote Control Operating Range

The remote control uses infrared transmission to control the projector. It is not necessary to point the remote directly at the projector. Provided you are not holding the remote perpendicular to the sides or the rear of the projector, the remote control will function well within a radius of about 10 meters (32 feet) and 15 degrees above or below the projector level. If the projector does not respond to the remote control, move a little closer.

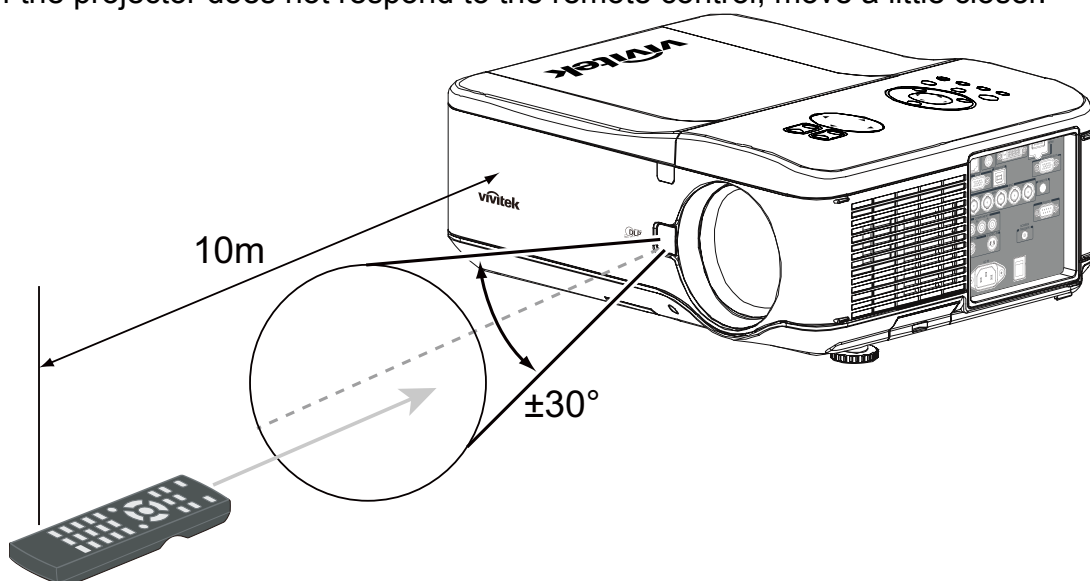

Important:

- Avoid using the projector with bright fluorescent lighting turned on. Certain high-frequency fluorescent lights can disrupt remote control operation.
- Be sure nothing obstructs the path between the remote control and the projector.
- Do not expose the remote control to high temperature or humidity; otherwise, the remote control will not work functionally.

Turning On the Projector

Once the projector is correctly located and the power cable and other connections are in place, it is important that the projector is powered on correctly in order to avoid damage to components and unnecessary wear and tear.

Refer to the following guide to power on the projector.

1. Connect the power cable (A). Press the main power switch to the on (I) position as shown (B), the Power LED lights orange.

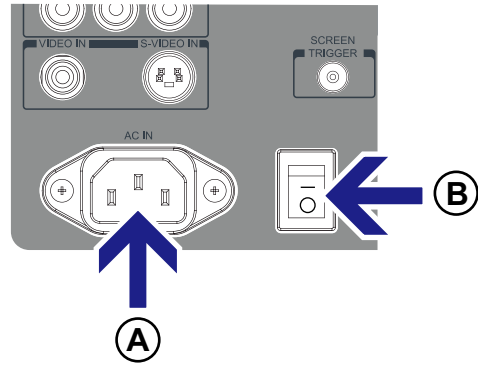

2. Press the POWER button on the control panel or ON button on the remote control once, the Power LED flashes green and the internal cooling fan starts.

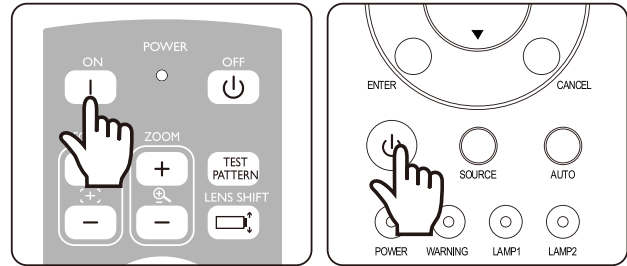

3. After approximately 10 seconds, the Lamp1 and Lamp2 LEDs light green and the Power LED flashes more rapidly.
4. Once the power LED is lit a solid green, the projector is ready for use.

Note:

- If any of the LEDs remain flashing or blink, there may be a problem with the startup. Please refer to the Troubleshooting section.

Turning Off the Projector

Once the projector is no longer required, it is important to shut it down correctly to avoid damage or unnecessary wear and tear to the projector.

Note:

- Do not unplug the power cable from the wall outlet or projector when the projector is powered on. Doing so may cause damage to the AC IN connector of the projector and (or) the prong plug of the power cable. To turn off the AC power supply when the projector is powered on, use a power strip equipped with a switch and a breaker.

Refer to the following guide to shut down the projector.

- Press the POWER button on the control panel or OFF button on the remote control once, the Power Off window displays.

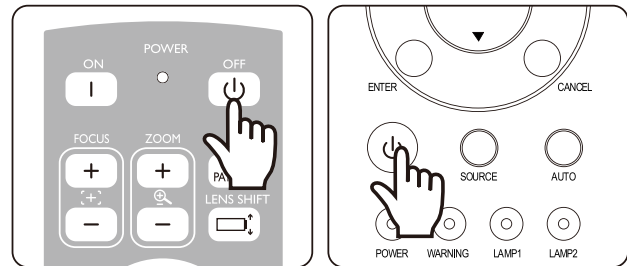

- Press the POWER button again on the OSD control panel or remote control to confirm power off. The cooling fans continue to operate and the power LED flashes orange. The cooling fans stop operating when the projector turns off.

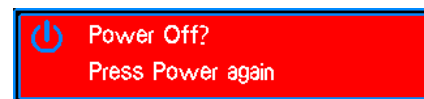

- The projector enters Standby mode when the power LED lights orange.
- Press the Main Power switch to the off position (O) to turn off the projector.

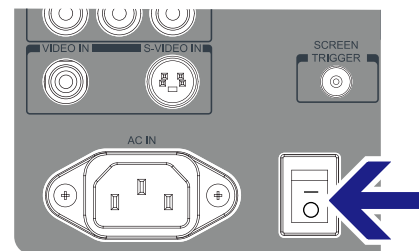

About Direct Power Off

The projector has a feature called "Direct Power Off". This feature allows the projector to be turned off (even when projecting an image) using a power strip equipped with a switch and a breaker.

Note:

- Before using Direct Power Off, be sure to allow at least 20 minutes immediately after turning on the projector.

Adjusting Projected Image Position

The projector is equipped with powered Lens control features, the projected image can be vertically shifted without moving the projector. The lens shift range is shown in the percentage of the screen height. The project installed on the desk can move up by 50% (0.5V).

Vertical lens shift

The projected image can be moved up by 50% (0.5V) if the project is installed on the desk.

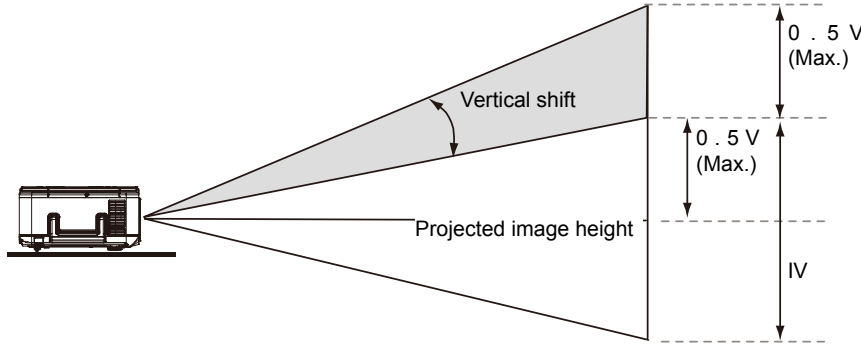

The projected image can be moved down by 50% (0.5V) if the project is installed via a ceiling mount.

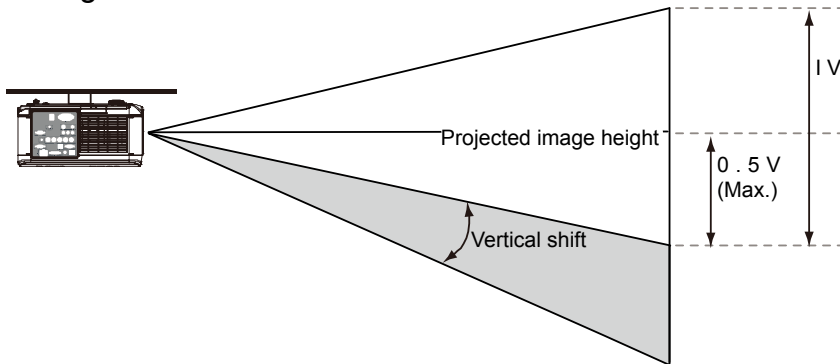

Horizontal lens shift

The image can be shifted horizontally to the right or left by 10% (0.1H) without moving the projector.

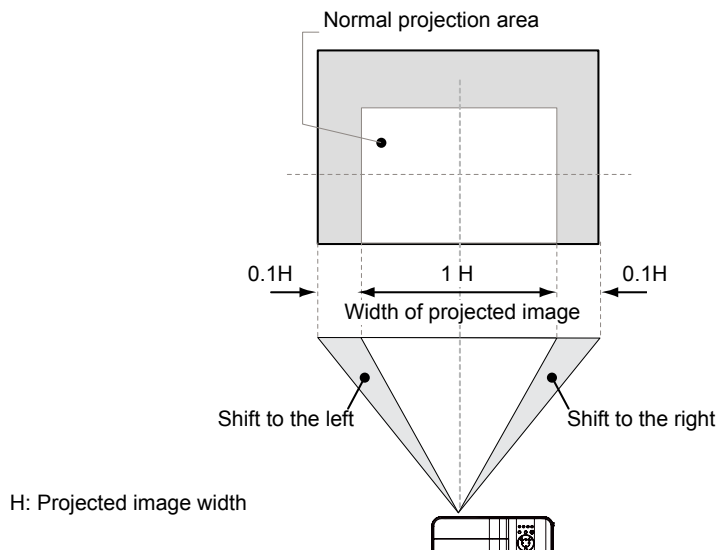

Adjusting the Focus and Zoom

The focus and zoom can be adjusted manually from the projector control panel or remote control. Refer to the following guides to adjust the focus and zoom manually.

Press the Focus or Zoom button on the control key panel or remote control to adjust the focus or zoom effect using the increase and decrease buttons as required.

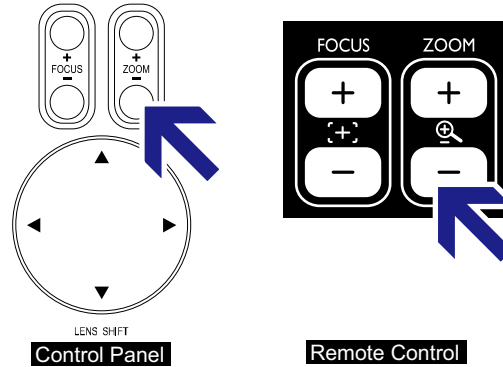

Displaying Test Pattern to Align the Projected Screen

The built-in test pattern is provided for installation and adjustment such as Crosshatch pattern. You can select Test Pattern on OSD or TEST PATTERN button on the remote control to display the test pattern menu, use ◀▶ or ▲▼ to select desired test pattern for alignment, select to Off to exit the test pattern or return to projected image.

PICTURE	SIGNAL	SETUP	INSTALLATION	SERVICE
Projection Mode				Desktop Front
Standby Mode				Network Standby
High Altitude				Off
Auto Power Off				Off
Auto Power On				Off
RS232				◀/▶
Network				◀/▶
Lens Control				◀/▶
Test Pattern				◀/▶

RETURN = Back | Item Adjust ◀▶ | Scroll ▲▼

Making Connections

Follow the instructions below to connect DU6675 projector to the video source, external control equipment (if any). When connecting to the equipment, use the correct signal cable to connect to the signal source and ensure that the cable is securely connected. Fasten the nut on the joint and connect the signal source equipment to the projector according to the figure below.

Connecting to Personal Computer

You can connect the PC signal to be projected to the projector through the DVI-D, HDMI, VGA or RGBHV (BNC) cable. If the signal to be input is VGA signal, connect the VGA cable to the external display to simultaneously monitor the projected content.

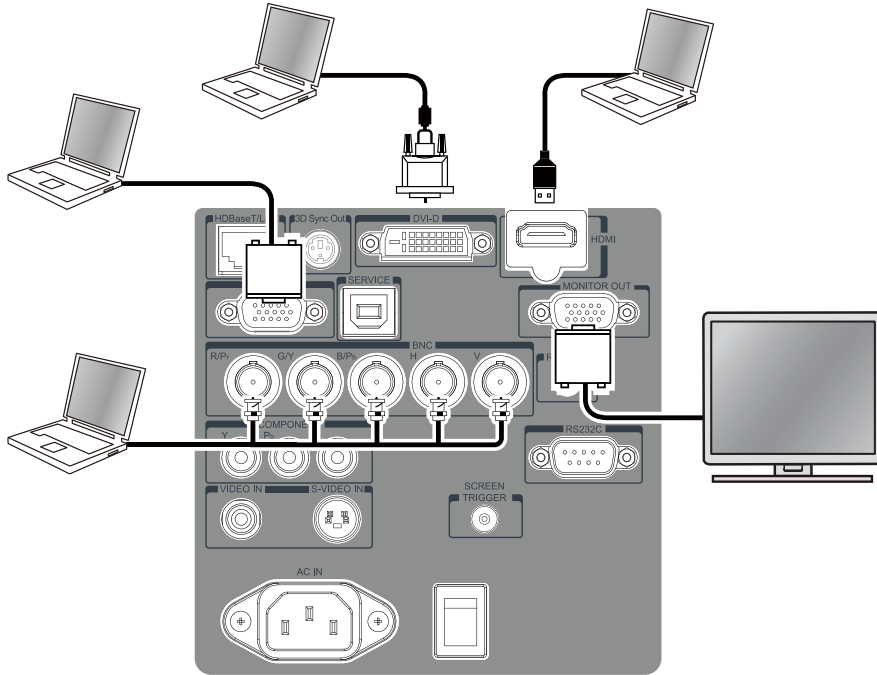

Connecting to the Video Device

Connect the video equipment to the input port of the projector via the DVI-D, HDMI, Component Video, Composite Video or S-Video Connector.

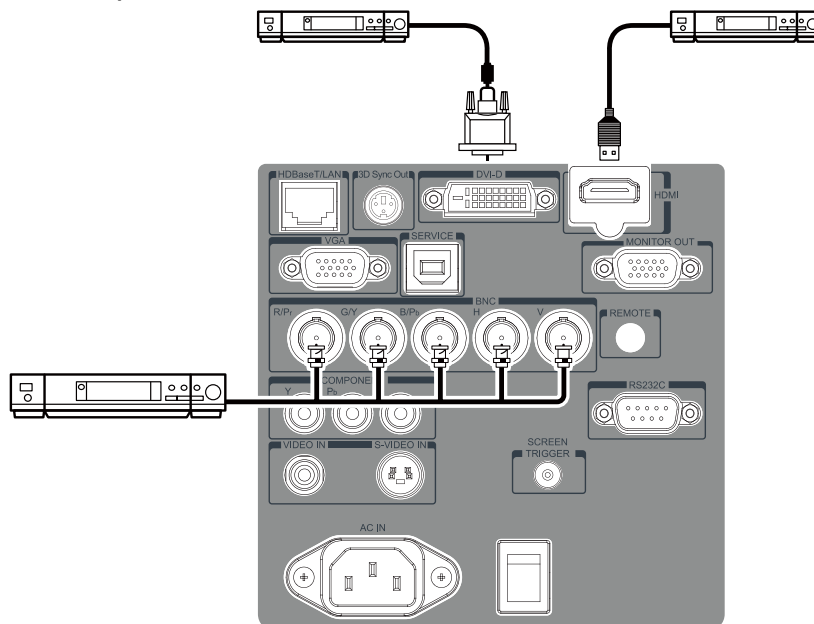

Connecting to the Control Equipment

The projector has the following control port for connecting to the control equipment:

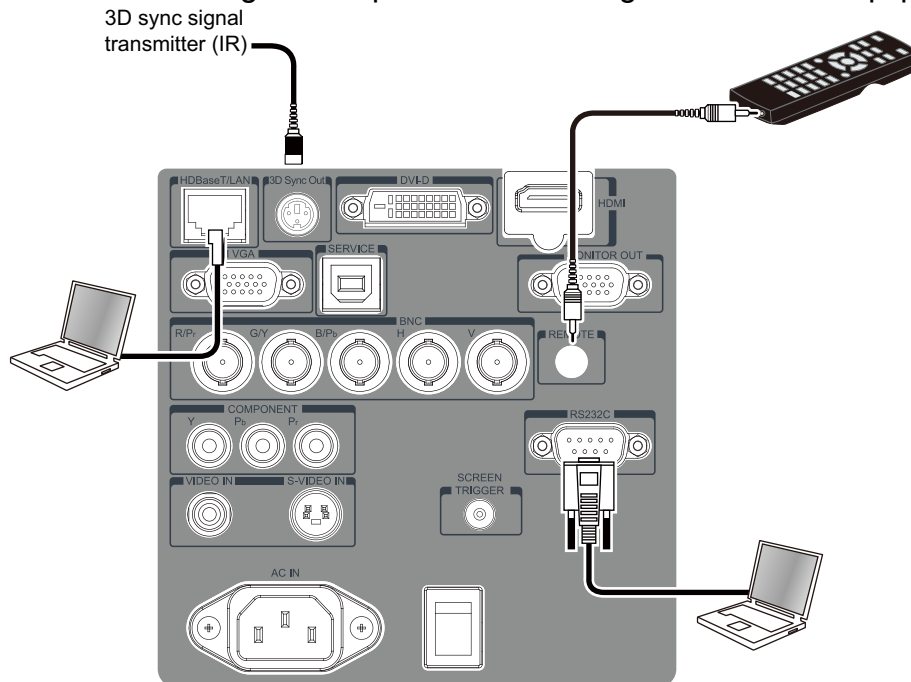

- **HDBaseT/LAN (Network control):** The projector supports network control via LAN/HDBaseT terminal. LAN and HDBaseT share the port. If only network control is used, you can connect the LAN on the projector to PC or through the local network. Refer to the Remote Communication Guide for more detail information.
- **RS-232 (RS-232 control):** The projector can be controlled by RS-232 command via connecting the projector to PC or control system through the standard 9-pin serial cable. Refer to the Remote Communication Guide for detail information.
- **Wired remote control:** If the projector cannot receive the IR signal from the remote control due to the overly long distance or obstacles, you can connect the cable to the IR remote control or the external IR transmitter (optional) via the WIRE port to expand the working range of the remote control.
- **3D Sync Out:** Connect to 3D IR sync signal transmitter.

Note:

- If the wired remote control cable or the external IR transmitter is inserted to the incorrect port, such as Trigger, the remote control or the IR transmitter may be damaged. Make sure whether the port is correct.

Connecting to the Screen Trigger

If your projection system includes the Electric projection screen and other 12V trigger device, you can connect these devices to the Trigger and configure the settings on OSD. The projector will output 12V signal when turning on the projector.

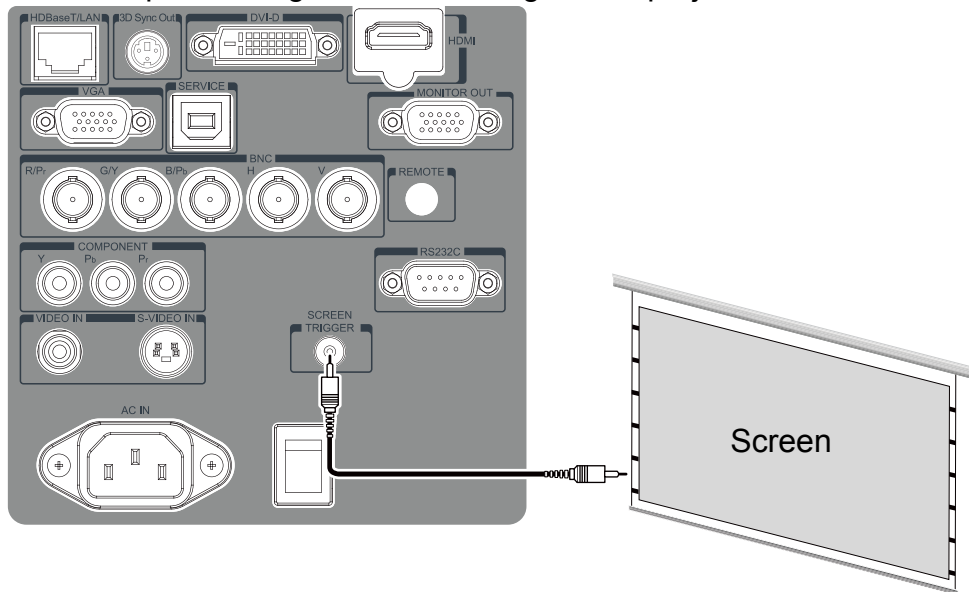

Connecting to External HDBaseT Transmitter

The projector has a built-in HDBaseT receiver. With HDBaseT transmitter (optional), the video, RS-232 and LAN signals can be sent to the projector via a single RJ-45 cable. If HDBaseT you purchased supports to output the IR remote control, the control signals from the IR remote control can be sent to the DU6675 projector via the RJ-45 cable.

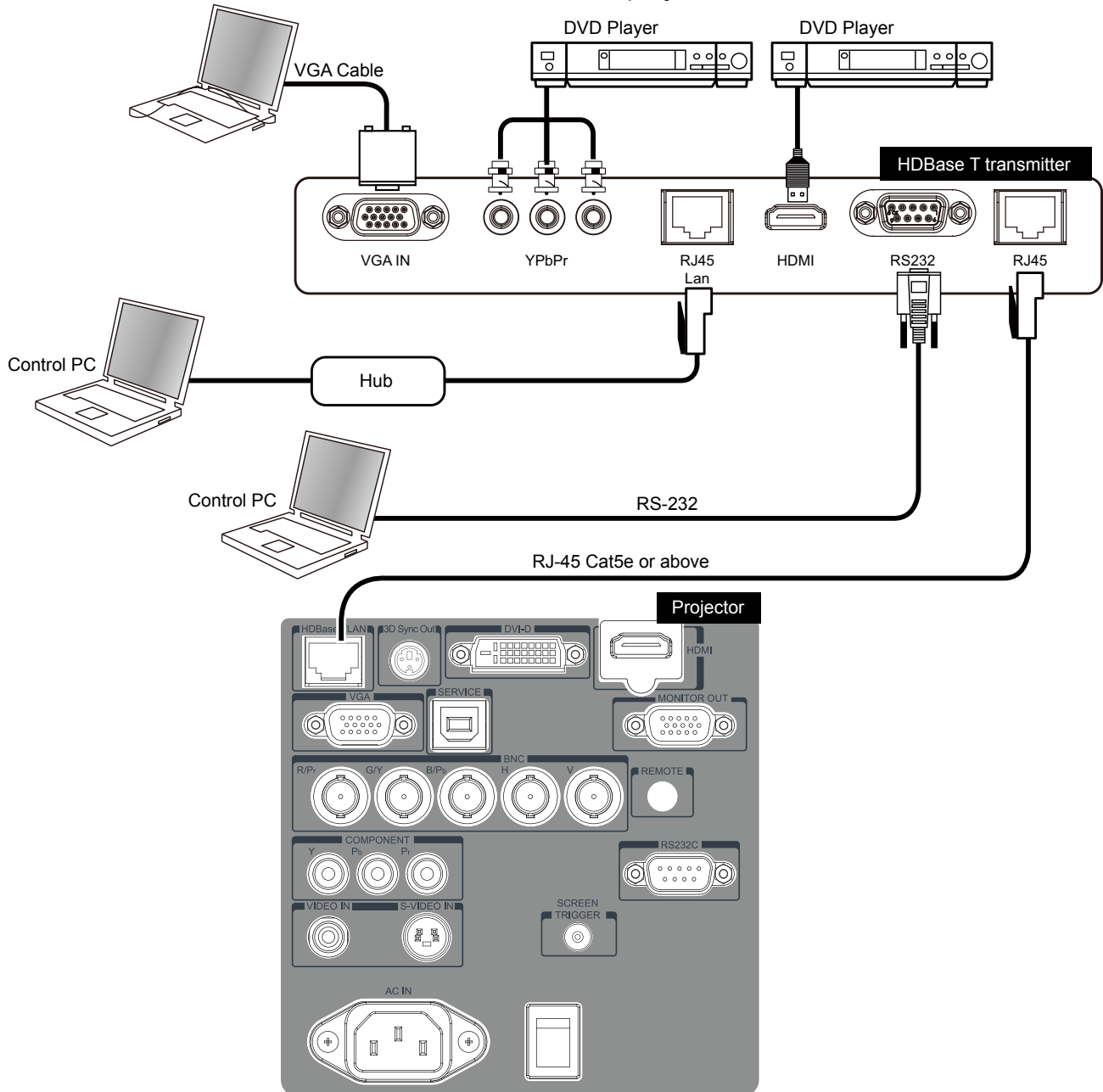

Note:

- The projector supports the video signal, R-232, IR remote control and the reception of the network control signals but do not support Power over Ethernet (PoE).
- Set the INSTALLATION -> RS232 -> Channel on the OSD menu to HDBaseT if you want to use the external HDBaseT transmitter to send the RS232 command to the projector via the RJ45 cable, the baud rate will switch to 9600 automatically.
- If the command is sent via the HDBaseT transmitter, the longest transmission distance is 100 meters. The projector may be interrupted or interfered, or the control signal cannot be sent if the transmission distance is exceeded.
- Use the RJ-45 Cat5e or above cable and avoid entwining. Entwining may cause damage, poor signal transmission, or reduce the transmission distance and degrade the image quality.

CONVENIENT FEATURES

Changing the OSD Language

The project can show the English, French, Spanish, Deutsch, Portuguese, Simplified Chinese, Traditional, Japanese and Korean menu. Press MENU to show OSD then press ◀▶ to select SETUP menu. Press ▲▼ to select the language to be used.

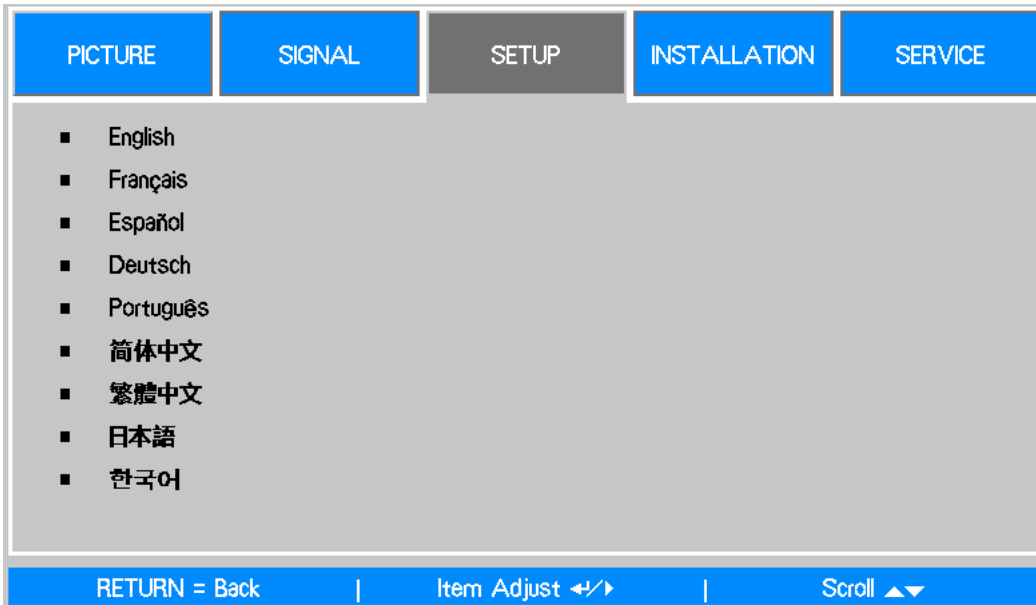

Selecting an Input Source

The Input Source can be selected from the projector's control panel or from the remote control unit. Refer to the following guide to select the Input Source.

1. Press SOURCE button on the control panel or INPUT button on the remote control to display Input Selection Menu
2. Select the required source using ▲ or ▼ and press ENTER button to confirm the input selection.
3. Return to the projected image by pressing RETURN or MENU button.

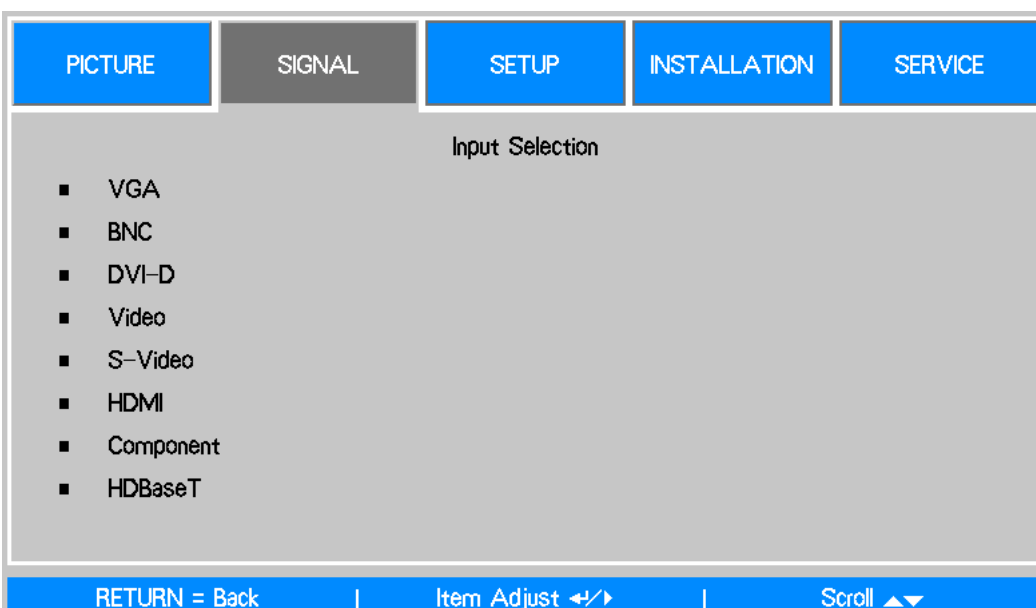

Changing Lamp Power

There are three Lamp power mode options, Normal, Eco and Custom Lamp Power. The Normal mode is used for every-day standard projection, whereas the Eco mode is used for saving power and lamp life. Custom Lamp power can be used for fine tuning the brightness of the projector. To change the Lamp Mode, refer to the following guides.

1. Press MENU on the projector's OSD control panel or on the remote control to display the main menu. Use ◀ or ▶ to select SETUP menu.
2. Use ▲ or ▼ to select Lamp power and ◀ or ▶ to set to Normal, Eco mode or Custom Power Level.

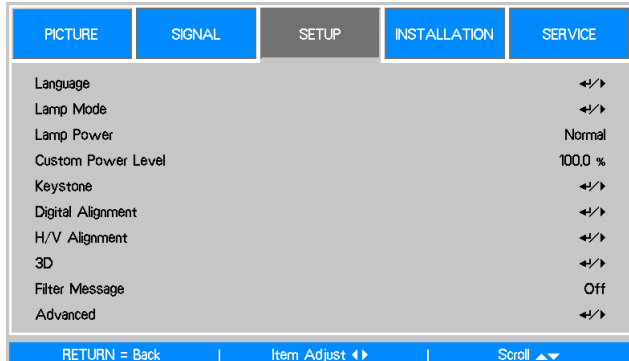

Note:

When the projector is in Eco mode, brightness may be affected.

- Normal Mode: 100% Brightness
- Eco Mode: approx. 80% Brightness
- Custom Power Level: The adjustable range is 100% to 82%(24 steps); this option allows you to adjust lamp power by step.

Freezing a Picture

The projected image can be frozen for short periods of time by using the remote control. This feature is useful for capturing still images from movies or freezing an animation at a particular point. To freeze the projected image, refer to the following guide.

1. Press the FREEZE button on the remote control once to freeze the projected image.

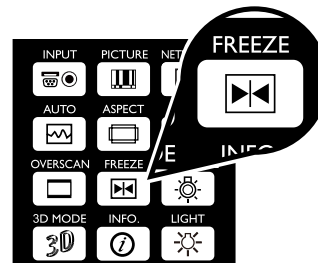

2. Resume the projected image, press the FREEZE button once more.

Blanking the Image

This feature allows you to temporarily stop projection, the projected image is blanked once BLANK button on the remote control is pressed, press once again to resume the projection.

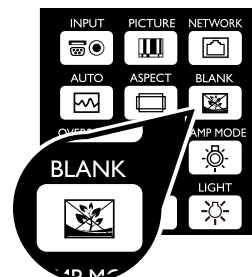

Correcting Keystone Distortion

When the image is projected either from the top or from the bottom toward the screen at an angle, the image becomes distorted. Use Keystone function to correct the distortion, the adjustable range is approximately +/-30 degree. The following are conditions under which the maximum angle is achieved:

- When the standard lens is used.
- When the lens shift is set to the center point.
- Image is projected in Wide mode.

Use ◀ or ▶ to select SETUP\ Keystone to enter Keystone menu.

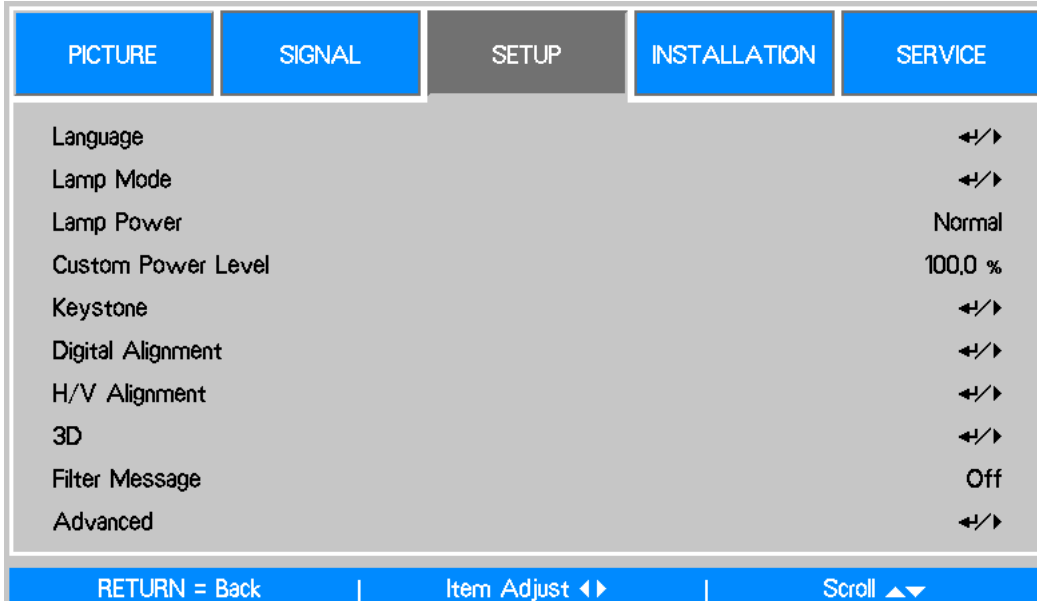

Use ▲ or ▼ to select H Keystone or V Keystone to correct the distortion.

H Keystone: Use ◀▶ to correct the distortion in horizontal direction.



V Keystone: Use ◀▶ to correct the distortion in vertical direction



Preventing the Unauthorized Use of the Projector

Using the Control Panel Lock

This function allows you to lock control panel on the projector; set it to On to lock the control panel. Otherwise, set it to off to unlock the control panel.

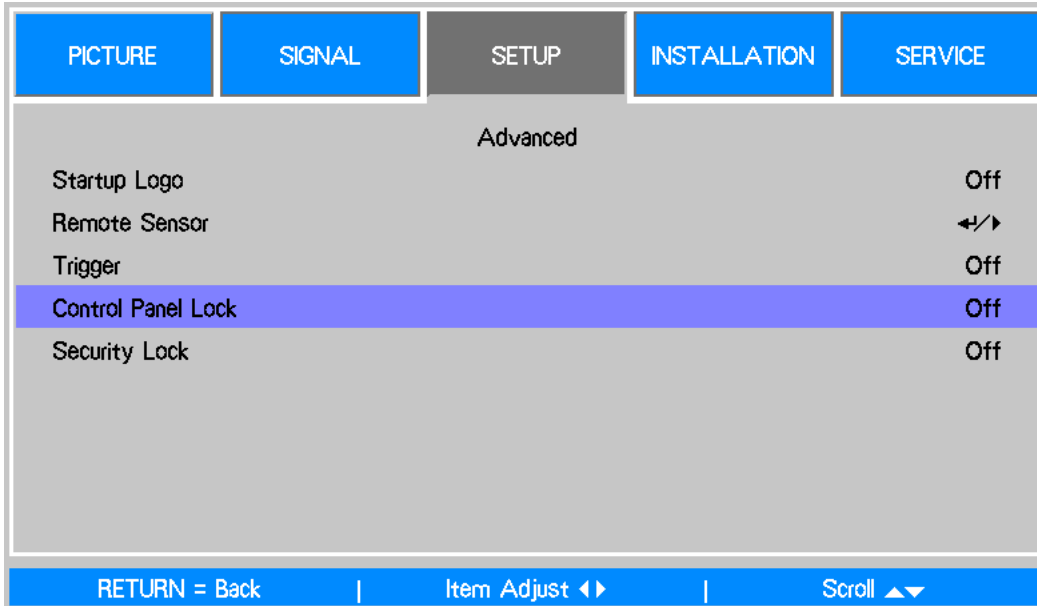

Using the Security Lock

The projector has a built-in security feature to lock the OSD control panel and deny remote control operation. The security feature has no default keyword; in the first instance of enabling the security feature, the user must define a keyword.

Locking the projector

To setup the security keyword, refer to the following guide.

1. Press MENU on the OSD control panel on the projector or remote control to display the Main menu.
2. Use arrow keys to select Security Lock under SETUP\Advanced menu.
3. Enter the password by remote control key and use ▲▼◀▶ to set up the PIN code.
4. Once the PIN code is set, the PIN code window is displayed when any control button is pressed.

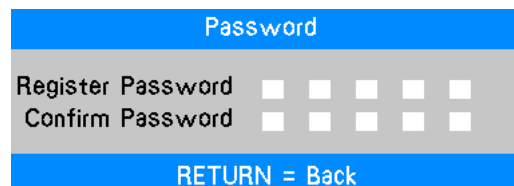

Unlocking the Projector

To unlock the projector, refer to the following guide

1. When the projector is locked, either by re-quest during operation or at start up, the locked message is displayed.
2. To unlock the projector, enter the previously defined PIN code to activate the projector.

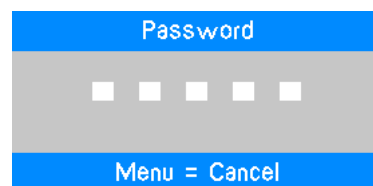

Using the Physical Lock

If you are concerned about security, attach the projector to a permanent object with the Kensington slot and a security cable.

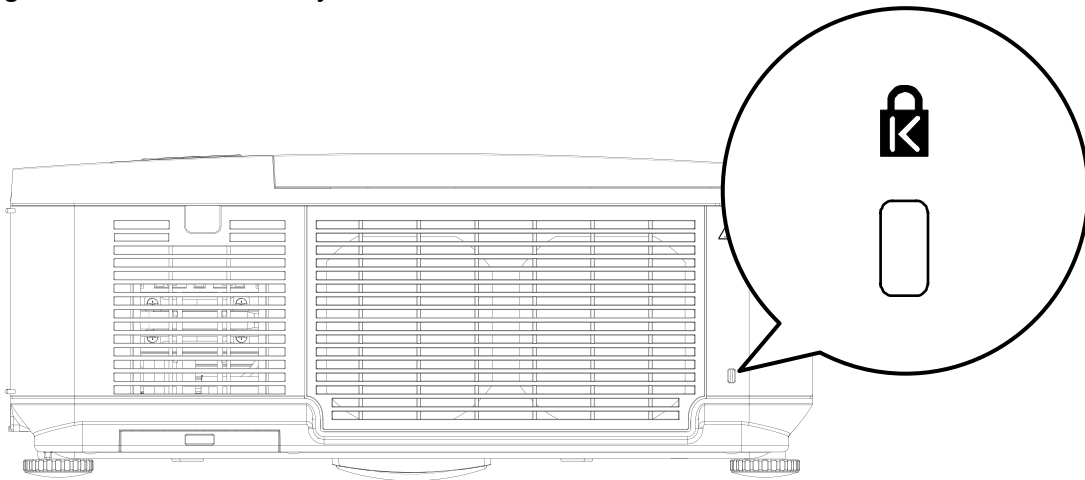

Getting Information

The Information screen provides details of the projector status such as lamp status, usage...etc. To access the Information, refer to the following guide.

1. Press MENU on the projector's OSD control panel or remote control to display the Main Menu. Scroll to the Installation Information menu using ▲ or ▼ and press.
2. The Information menu is displayed as the default view. The menu items in this screen are for display and cannot be modified.
3. Press CANCEL or MENU to return to the projected image.

PICTURE	SIGNAL	SETUP	INSTALLATION	SERVICE
Model :		DU6675		
Serial Number :		SN-1234567890000366666		
Software Version :		MP01-0D06-LD06-RE04-SP03-PD06-9E04-3090		
Lamp Status		↔		
Source Information		↔		
Usage Time		↔		
Filter Timer Reset		↔		
Factory Reset		↔		
RETURN = Back		Item Adjust ◀▶		Scroll ▲▼

Using On-Screen Display

Navigating the OSD

You can use the remote control or the buttons on the top of the projector to navigate and make changes to the OSD. The following illustration shows the corresponding buttons on the remote control and on the projector.

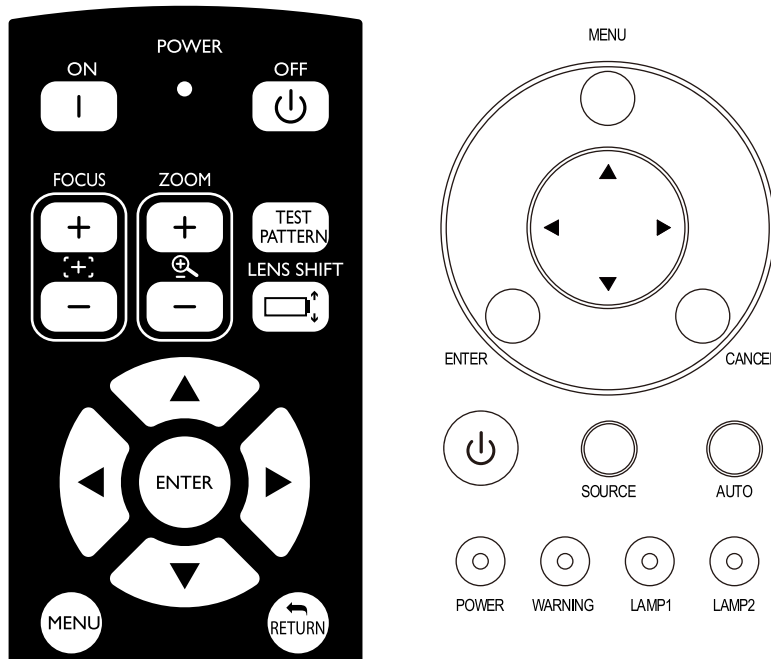

1. To open the OSD, press the MENU button on the OSD control panel or remote control. There are five folders on the menu. Press the cursor ◀ or ▶ buttons to move through secondary menus.
2. Press ▲ or ▼ to select menu items and ◀ or ▶ to change values for settings.
3. Press RETURN to exit a submenu or to close menu.



Menu Tree

Use the following table to quickly find a setting or determine the range for a setting.

Main Mnu	Submenu			
Picture	Picture Mode	High Bright		
		Presentation		
		Video		
		Brightness		
		Contrast		
		Saturation		
		Hue		
		Sharpness		
		Color Temperature	Native	
			6500K	
	Gamma	7800K		
		9300K		
		2.2		
		Film		
		Graphic		
Auto Sync	Video			
	PC			
	S Curve			
	Advance Setting	Input Balance		
		Red Offset		
		Green Offset		
		Blue Offset		
		Red Gain		
		Green Gain		
		Blue Gain		
HSG				
Red				
Green				
Blue				
Cyan				
Magenta				
Yellow				
White				
	Noise Reduction			
	Dynamic Black	On		
		Off		
Signal	Input Selection	VGA		
		BNC		
		DVI-D		
		Video		
		S-Video		
		HDMI		
		Component		
		HDBaseT		
		Auto Search	On / Off	
		Auto Sync Adjust	Always / Auto	
	Auto			
	Color Space	YCbCr		
		YPbPr		
		RGB-PC		
		RGB-Video		
VGA Setup		H Total		
	V Start			
	H Phase			
	V Start			
Aspect Ratio	5:4			
	4:3			
	16:10			
	16:09			
	1.88:1			
	2.35:1			

Main Mnu	Submenu			
Signal	Overscan	Auto Native Off On		
	Background	Blue Black Logo		
SETUP	Language	English, Français, Español, Deutsch, Português, 简体中文, 繁體中文, 日本語, 한국어		
	Lamp Mode	Dual Single Lamp 1 Lamp 2		
	Lamp Power	Normal Eco Customer Power level		
	Customer Power level			
	Keystone	H Keystone V Keystone		
	Digital Alignment	Digital Zoom Digital Pan Digital Scan Reset		
	H/V Alignment	H Zoom V Zoom H Shift V Shift Reset		
	3D	3D Format	Off Auto Side by Side Top/Bottom Frame Sequential	
		DLP-Link	On off	
		3D Swap	Normal Reverse	
		3D 24Hz Display	96Hz 144Hz	
		Filter Message	Off / 100/H 200H / 500 H/ 1000H	
		Filter Message Advanced	Startup Logo	On Off
			Remote Sensor	Front/Back Front Back HDBaseT
		Trigger	On Off	
		Control Panel Lock	On Off	
		Security Lock	On Off	
Installation	Projection Mode	Desktop Front Desktop Rear Ceiling Front Ceiling Rear Upward Front Downward Front		
	Standby Mode	Network Standby Normal		
	High Altitude	On/Off		
	Auto Power Off	On/Off		
	Auto Power On	On/Off		

Main Mnu	Submenu				
Installation	RS232	Baud Rate	38400, 19200, 9600		
		Channel	Local HDBaseT		
	Network	IP Address			
		Subnet Mask			
		Gateway			
		DNS			
		DHCP		On/Off	
		Apply		No/Yes	
	Lens Control	MAC Address			
		Zoom			
		Focus			
	Test Pattern	Lens shift			
		Color Bar			
		Cross Hatch			
		Burst			
		H Ramp			
		Red			
Green					
Blue					
White					
Black					
Off					
Service	Model Serial Number Software Version Source Information	Active Source			
		Pixel Clock			
		Signal Format			
		H/V Refresh Rate			
	Lamp Status	Sync Type			
		Sync Polarity			
		Scan Type			
		Video Type			
		Lamp 1		On/Off	
		Lamp 2		On/Off	
		Usage Time	Lamp 1 Life Remaining		
			Lamp 2 Life Remaining		
			Lamp 1 Time		
			Lamp 2 Time		
	Filter Timer Reset Factory Reset	Power On Time			
		OK / Cancel			
		OK / Cancel			

OSD Operation - PICTURE

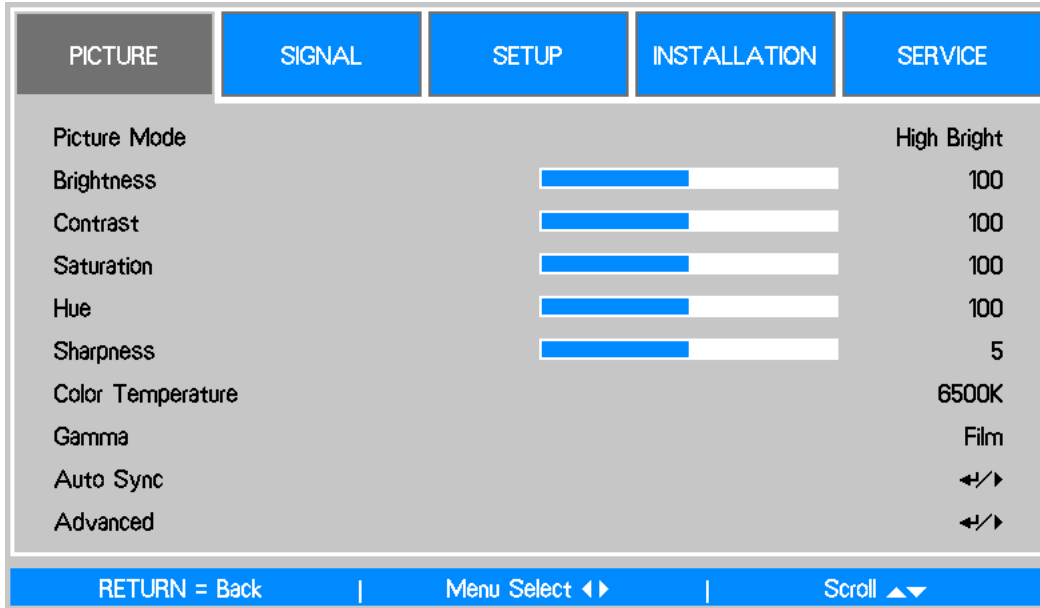

Picture Mode

Use ◀ or ▶ to select a set of preset picture mode.

High Bright: The highest brightness output mode is suitable for the occasion where high brightness is needed.

Presentation: The best image effect is suitable for the presentation or picture.

Video: The best picture mode is suitable for play of the video.

Brightness

Use ◀ or ▶ to increase or decrease the brightness of the image.

Contrast

Use ◀▶ to adjust the contrast of the projected image.

Note:

The brightness and contrast controls affect each other. To obtain the best setting, fine-tune of the brightness setting might be needed after adjustment of the contrast.

Saturation

Use ◀▶ to adjust the saturation level of the color (the higher the level, the higher the saturation).

Hue

Use ◀▶ to adjust the level of hue for reproduction of the true color.

Main Color	Hue		
R	Magenta	↔	Yellow
G	Yellow	↔	Cyan
B	Cyan	↔	Magenta
C	Green	↔	Blue
M	Blue	↔	Red
Y	Red	↔	Green

Sharpness

Use ◀▶ to adjust the sharpness. The purpose of this adjustment is to change the value of the high-frequency detail.

Color Temperature

Use ◀▶ to adjust the color temperature of the projected image, the option can be 6500K, 7800K, 9300K and Native.

Gamma

When the ambient light is too bright and may affect the display of the details in the darker area of the image, you can select from the following gamma options to adjust the chrominance of the image.

2.2: Set the chrominance correction to 2.2.

Film: Set the chrominance correction to approximately Gamma 2.2.

Graphics: This option is used for the PC presentation that needs higher brightness at the cost of the gray scale accuracy.

Video: This is similar to the Film option, but there is a different in the dark area of the image to correspond to the function that the camera uses for creation of the image.

S Curve: S curve is to extend dynamic range while maintaining visual contrast, this reduces contrast in highlights and deep shadows while maintaining or boosting it in middle tones.

Auto Sync

Use this function to execute the Auto Sync for the input signal.

Input Balance

PICTURE	SIGNAL	SETUP	INSTALLATION	SERVICE
Advanced \ Input Balance				
Red Offset	<input type="range"/>			100
Green Offset	<input type="range"/>			100
Blue Offset	<input type="range"/>			100
Red Gain	<input type="range"/>			100
Green Gain	<input type="range"/>			100
Blue Gain	<input type="range"/>			100

There are two options for fine tuning Red, Green and Blue color

Offset: These three options will shift the color spectrum for the whole image and change its brightness, if minimal amount of red, green or blue appears in the gray areas, you can adjust the offset of the corresponding color accordingly. By increasing the offset, the image brightness will become lower.

Gain: These three options are used to increase or decrease the range of color input for the entire image. If minimal amount of red, green or blue appears in the gray areas, lower the gain of the corresponding color accordingly. As gain increases, the contrast of the image will become lower.

HSG

HSG is a function to adjust Hue, Saturation and Gain independently, it allows for specified color adjustments that are more intuitive. You can adjust Hue, Saturation and Gain for Red, Green, Blue, Cyan, Magenta, Yellow and white independently.

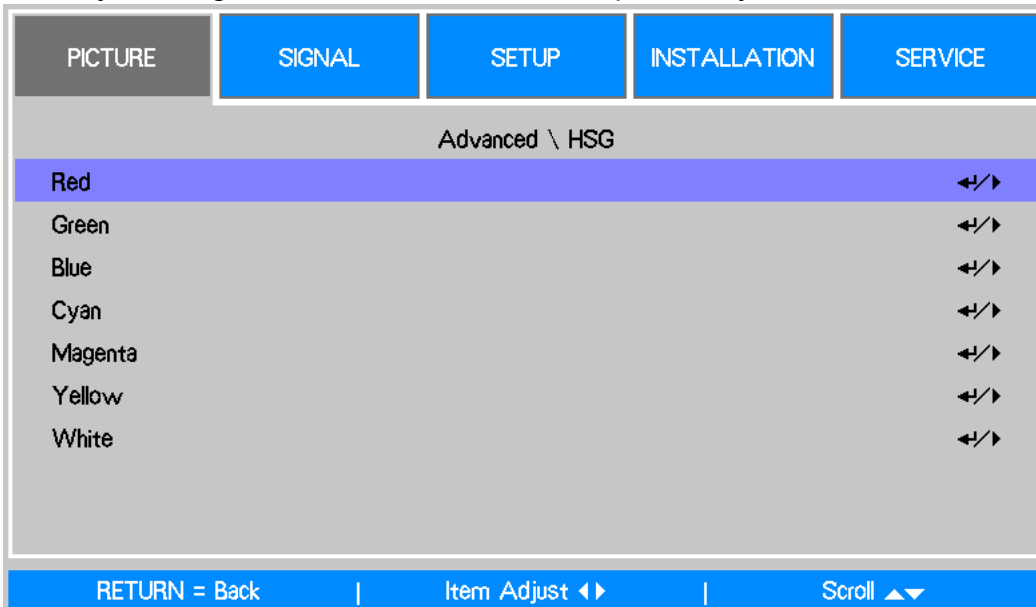

Noise Reduction

Use ◀▶ to adjust the noise of the projected image. This function is suitable for removing the noise of the image in interlaced scanning input. Generally, noise reduction can lower the value of the high-frequency detail and make the image softer.

Dynamic Black

Use the ◀▶ function to turn on/off Dynamic Black; it can be used to enhance the black level of the projected image.

OSD Operation - SIGNAL

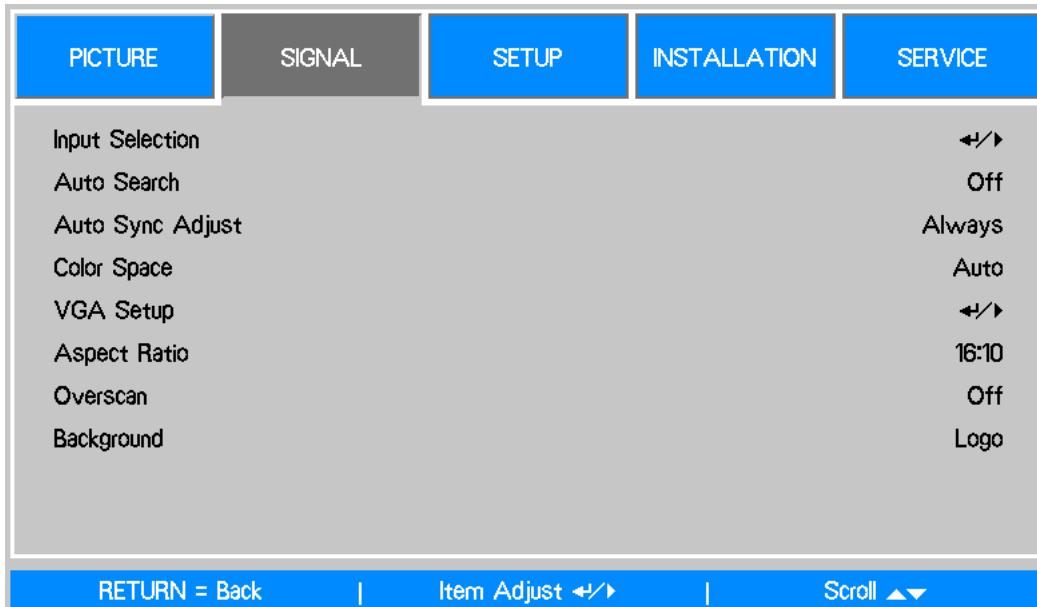

Input Selection

This function is same as the shortcut key on the remote control. You can use the remote control or this function to select the correct input source.

VGA: Select input source to VGA.

BNC: Select Input source from BNC, the input source can be RGBHV or Component signal from computer or component video enabled device.

DVI-D: Select input source from DVI-D output of the computer or media device.

Video: Select input source from video output of the media device.

S-Video: Select input source from S-Video output of the media device.

HDMI: Select input source from HDIMI output of the computer or media device.

Component: Select input source from component output of the media device.

HDBaseT: HDBaseT input source from the HDBaseT transmitter.

Auto Search

Use the ◀▶ function to turn on/off Auto Search for the input source.

Auto Sync Adjust

You can use this function to set auto synchronization for the input signal.

Auto: The projector memorizes 10 sets of signal sources that you have used lately.

When the Auto option is selected, the projector will choose the signal that you use last.

Always: The auto sync function is executed every time.

Color Space

This function allows you to change the corresponding color space for the input signal. In most cases, the correct color space can be selected automatically by Auto mode. If the selection is not correct, you can use a specific color space forcibly by selecting one of the following options:

Auto: The projector detects the input signal and switches to the corresponding color space automatically.

YCbCr: Set the color space to ITU-R BT.601.

YPbPr: Set the color space to ITU-R BT.709.

RGB-PC: Use the RGB color space and set the black to 0, 0, 0 RGB while set the white to 255, 255, 255 RGB (if an 8-bit image is used).

RGB Video: Use the RGB color space and set the black to 16, 16, and 16 RGB while set the white to 235, 235, 235 (if an 8-bit image is used) to correspond to the luminance value defined in the digital component standard.

VGA Setup

Set the H Total, H Start, H Phase and V Start for the VGA signal display.

Aspect Ratio

This function allows the user to adjust the aspect ratio of the image.

Overscan

Noise may appear on the edge of the projected image, use this function to select Crop to hide the edge of the image or Off to display the original image.

Background

Use this function to specify the image to be displayed on the screen when no signal is input. You can select the Logo, Blue or Black.

OSD Operation - SETUP

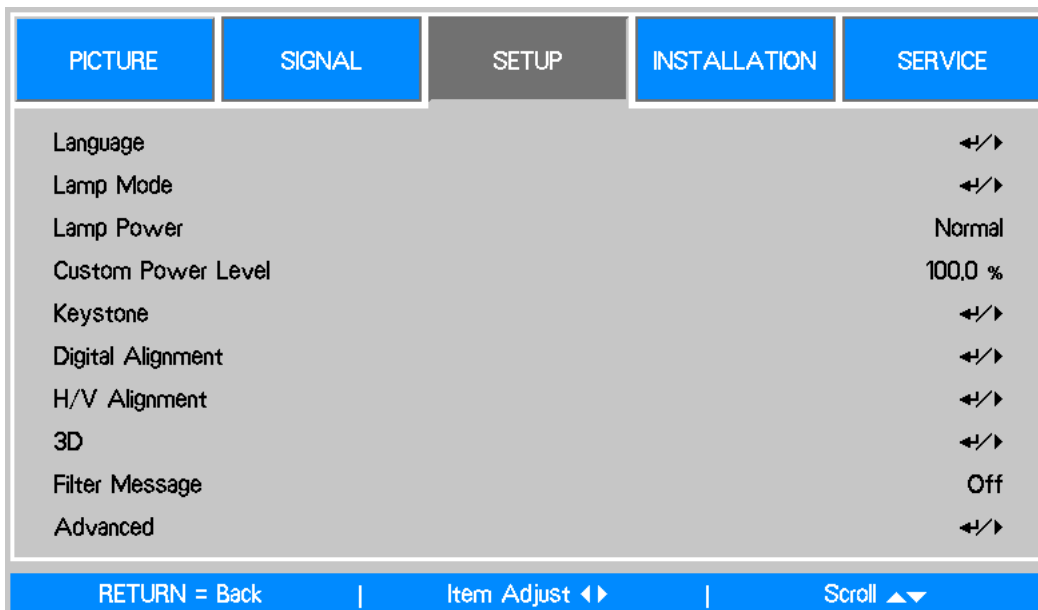

Language

Select the familiar OSD Menu language. English, French, Spanish, Deutsch, Portuguese, Simplified Chinese, Traditional, Japanese and Korean.

Lamp Mode

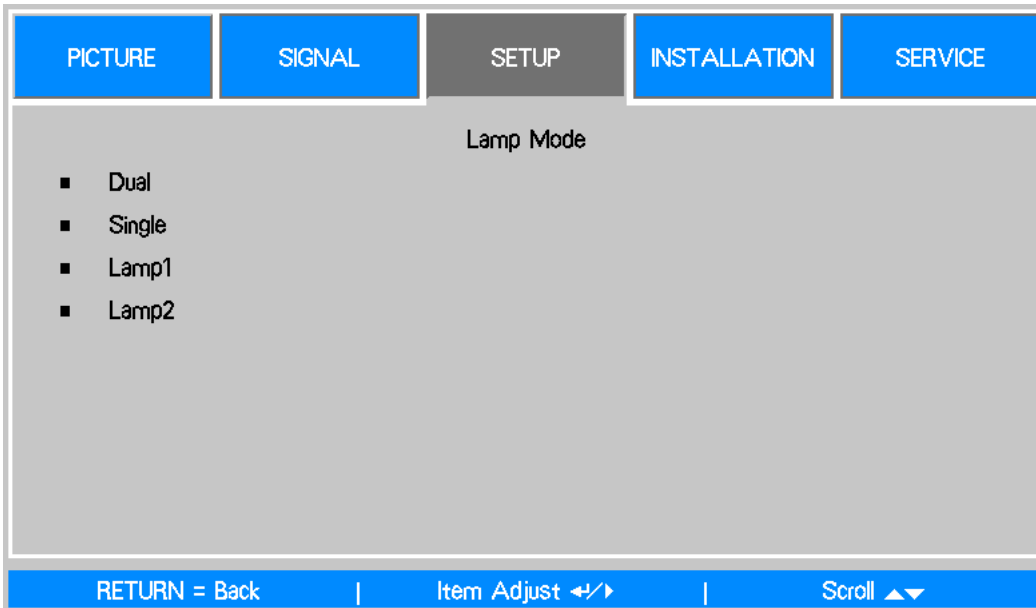

Use the ◀▶ function to select the single-lamp or dual-lamp mode.

Dual: Enable the dual-lamp projection mode.

Single: Use the single-lamp mode for the projection. The lamp is not specified in this mode, the projector selects the lamp that has the least operation hours automatically whenever it is turned on.

Lamp 1: Use Lamp 1 for projection. The system switches to Lamp 2 if Lamp 1 is abnormal in activation.

Lamp 2: Use Lamp 2 for projection. The system switches to Lamp 1 if Lamp 2 is abnormal in activation.

Note:

- In the Lamp 1 or Lamp 2 mode, the projector will switch to another lamp when the set lamp becomes abnormal. The corresponding LED indicator of the lamp will flash simultaneously for seconds and light up.
- When the lamp mode is set to Single, the setting will become valid upon turn-on of the projector next time.
- Quick switch of the lamp mode may affect the life of the lamp. The projector will disable the lamp mode function (highlighted) every time when a switch is conducted till the switch of the lamp mode is completed. The lamp mode options are not available before the switch of the lamp mode is completed receiver via control key button or RS-232 command.

Lamp Power

Use the ◀▶ function to select Normal, Eco or Custom Power Level mode.

Normal: Projection is carried out using the normal lamp power to obtain the brightest projection display.

Eco: Projection is carried out in the energy saving mode to ensure the longest service life of the lamp.

Custom Power Level: In addition to the Normal and Eco modes, the lamp power equal to 100% to 82% of the power in the Normal mode is used for fine tuning of the brightness in the Custom Power Level mode. This function can be used for quick installation and routine maintenance in multi-projector applications. Select this mode to enable the Custom Power Level function.

Custom Power Level

Select this function and use the ◀▶ to adjust lamp power between 100% and 82%, note that this function is valid only when Lamp Power is set to Custom Power Level.

Keystone

When the image is projected toward the screen at angle, the image becomes distorted trapezoid; this function can be used to correct the distortion.

H Keystone: Use ◀▶ to correct the distortion in horizontal direction.

V Keystone: Use ◀▶ to correct the distortion in vertical direction.

Digital Alignment

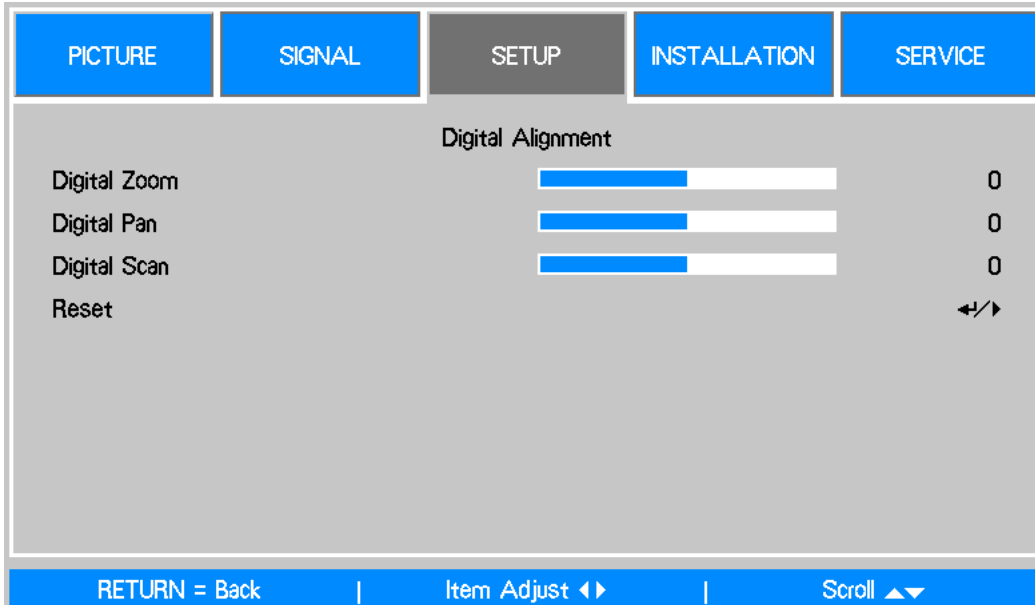

Select this function to enlarge the projected image.

Digital Zoom: Use ◀▶ to enlarge the projected image.

Digital Pan: Use ◀▶ to move the projected image horizontally. This function is only available when the projected image is enlarged.

Digital Scan: Use ◀▶ to move the projected image vertically. This function is only available when the projected image is enlarged.

Reset: Set the Digital Alignment back to the factory default value.

H/V Alignment

H Zoom: Use ◀▶ to narrow the horizontal size of the projected image.

V Zoom: Use ◀▶ to narrow the vertical size of the projected image.

H Shift: Use ◀▶ to move the narrowed projected image horizontally. This function is only available when the projected image is narrowed.

V Shift: Use ◀▶ to move the narrowed projected image vertically. This function is only available when the projected image is narrowed.

Reset: Set the H/V Alignment back to the factory default value.

3D

Set the 3D format and 3D sync signal. The projector detects the signal type and displays the available options for settings; the unavailable option is grayed out. Before performing the 3D setting, ensure that the input signal is connected. When there's no input signal, 3D setting can not be performed.

3D Format

Select this option and press the Enter button to enable 3D replay and set 3D option.

Off: Turn off the 3D Display Mode. When Auto, Side by Side, Top/Bottom or Frame Sequential is selected, the 3D mode will be turned on. To turn off the 3D Mode, select "Off" and press the Enter button.

Auto: Enable the 3D format to automatically detect the formats of Side by Side, Top/Bottom and Frame Sequential. This function may only be enabled for the input signal below:

- The input signal is HDMI 1.4 3D.
- The HDMI 1.4 3D signal connects to the projector through HDBaseT transmitter.

Side by Side: Manually switch the 3D Format to Side by Side. This option is only applicable to the HDMI input signal or the HDMI signal sent using HDBaseT transmitter.

Top/Bottom: Manually switch the 3D Format to Top/Bottom. This option is only applicable to the HDMI input signal or the aforementioned signal sent through the HDBaseT transmitter.

Frame Sequential: Set the format to Frame Sequential.

DLP Link: Set to activate or deactivate the DLP Link sync. signal.

3D Swap: If the 3D image viewed through the 3D glasses for the left and right eyes are inverse, set the 3D Swap to "Inverse". If the images are normal, keep the current.

3D 24Hz Display: Set the 3D 24Hz image frame rate to 144fps or 96fps, this option is only applicable when the input signal is 24Hz

Note:

- The projector provides DLP Link and 3D IR sync. After the 3D Mode is enabled, the built-in DLP Link or external 3D IR transmitter can be used to synchronize the signal of the 3D glasses. Or, you may turn off the DLP Link sync signal and only select the external 3D IR transmitter to synchronize the 3D signal.

Caution:

The people listed below shall be aware when watching 3D images:

- Children under six years in age.
- People who are allergic to light, unhealthy and have the history of cardiovascular.
- People who are tired or lack of sleep.
- People who are under the impact of drug or alcohol.
- Normally, it's safe to watch 3D images. However, some people might feel uncomfortable.
- Refer to the guidelines revised and released by the 3D League on December 10, 2008.
- People need to take a break for at least 5 to 15 minutes every thirty minutes or one hour.

Filter Message

This function allows you to set interval time to display a message for cleaning the filter; the available options are Off, 100H, 200H, 500H and 1000H. Please make sure to reset the filter Message after cleaning the filter.

OSD Operation - INSTALLATION

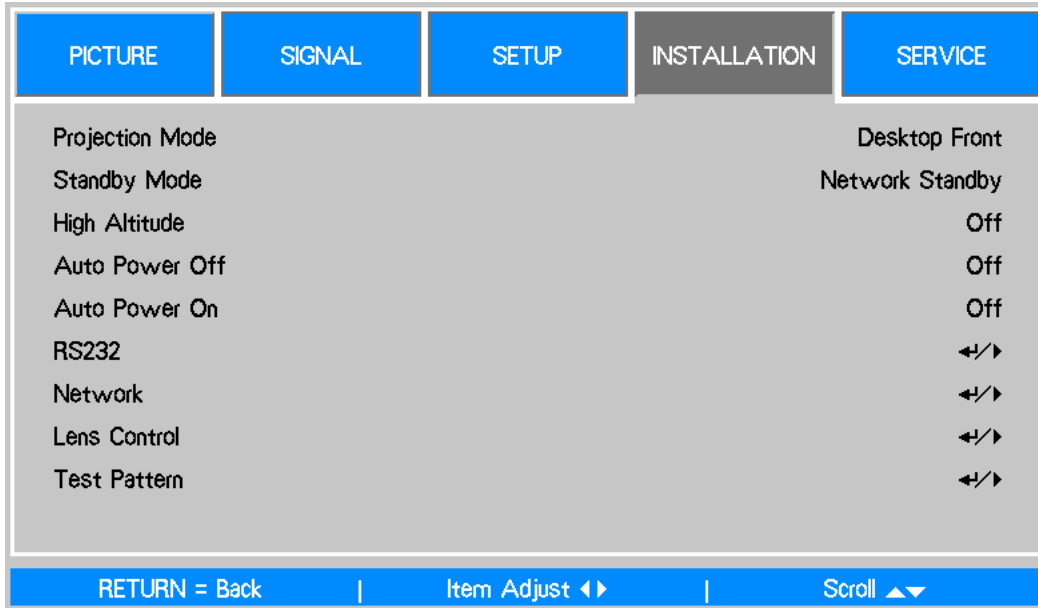

Projection Mode

Use the ◀▶ function to select a projection mode: Desktop Front, Desktop Rear, Ceiling Front, Ceiling Rear, Upward Front and Downward Front.

Note:

- In addition to flipping the projected image, the cooling fan will also be adjusted to the corresponding speed in order to maintain proper operating temperature of the projector.
- Incorrect Projection Mode setting may affect hot air exhausting from the projector the heat, high temperature may cause the projector goes into system protection , component damage or lamp damage.
- Brightness decay of upward or downward installation is faster than desktop or ceiling installation. Refer to laboratory test results, Lamp life may be reduced to 50-75% of the life which the projector is installed by Desktop or Ceiling installation. Recommend to regularly check the lamps and the brightness of projected image, please consult your local dealer if the projector will be installed upward or downward.

Standby Mode

Use the ◀▶ to select standby mode to Normal or Network Standby.

Network Standby: The projector maintains in the standby status at higher power (<6W) for the projector control via LAN. In this mode, the projector can be turned on via network control system.

Normal: The projector maintains in the standby status at the lowest power (<0.5W), the projector can be turned on using the remote control, RS-232 command.

High Altitude

Use this function to control the cooling fan of the projector, the default setting is OFF. Normally, the projector can operate normally when this function is set to OFF. The projector detects ambient temperature to regulate the cooling fan speed. However, the projector may turn off automatically if it is used in an environment at excessively high temperature or in an area at a high altitude. In this case, please enable this function by setting it to ON and have the cooling fan operate at a higher speed to control the internal temperature of the projector.

Note:

- High Altitude mode is for the place at an altitude of more than 5000 feet.

Auto Power Off

This function is set to OFF by default. When it is set to ON and no input signal is received within 20 minutes, the projector will turn off automatically.

Auto Power On

This function is set to OFF by default. When it is set to ON, the projector will turn on automatically when you connect it to an AC power source next time. You can use this function and the power switch (instead of the remote control) to turn on the projector. Set this function to OFF if you do not need to use it.

RS232

Baud Rate: Set the transmission rate to 38400, 19200, 9600. The setting of the transmission rate is dependent on the length of the RS-232 cable. Low transmission rate is usually set for long transmission cables. If RS-232 is used to control the projector, the signal is unstable or no communication is connected, select a suitable transmission rate.

Channel: The RS232 control command can be sent to the projector through its RS-232 port, the command can also be sent to the projector through the external HDBaseT transmitter to HDBaseT/LAN terminal of the projector. Set the following communication channels before sending the control command.

Local: The RS-232 control command is sent through the RS-232 port on the projector. Select an appropriate baud rate.

HDBaseT: Transmission is conducted from the external HDBaseT transmitter to the RJ-45 port on the projector. The baud rate is switched to 9600.

Network

PICTURE	SIGNAL	SETUP	INSTALLATION	SERVICE
Network				
IP Address				192.168.0.100
Subnet Mask				255.255.255.0
Gateway				192.168.0.1
DNS				192.168.0.1
DHCP				Off
Apply				◀/▶
MAC Address				00:18:23:00:00:01
RETURN = Back Item Adjust ◀▶ Scroll ▲▼				

Use this function to set up network configurations so that you can control the projector via the network.

Press ▲▼ and the Enter button to select Network and network settings:

IP Address: To specify an IP address, press the Enter button to show the IP address input window. Use the ◀▶ button to select the number in the address to be changed. Use the ▲▼ button to increase or decrease the number in the IP address.

IP Address				
192	.	168	.	0 . 100

Subnet: Set the subnet. The input method is same as the IP address.

Gateway: Set the gateway. The input method is same as the IP address.

DHCP: Set DHCP to ON/OFF. When DHCP is set to ON, the DHCP server will assign an IP address to the projector. The IP address will appear in the IP address window and you don't need to make any input. Otherwise, the domain does not or cannot assign any IP address, and 0. 0. 0. 0 is shown on the IP address window.

Apply: Select this button and press Enter. It takes the projector several seconds to execute the change of the network setting till the following message disappears.



For more information about the network control connection and setting, refer to Remote Communication Manual.

Lens Control

Select this function to open the Lens Control menu for Zoom, Focus or Shift adjustment. You can use the Enter button to switch the Zoom/Focus or Shift menu. Use ◀▶ to adjust zooming and horizontal shift of the lens, or use ▲▼ to adjust focusing and vertical shift of the lens.

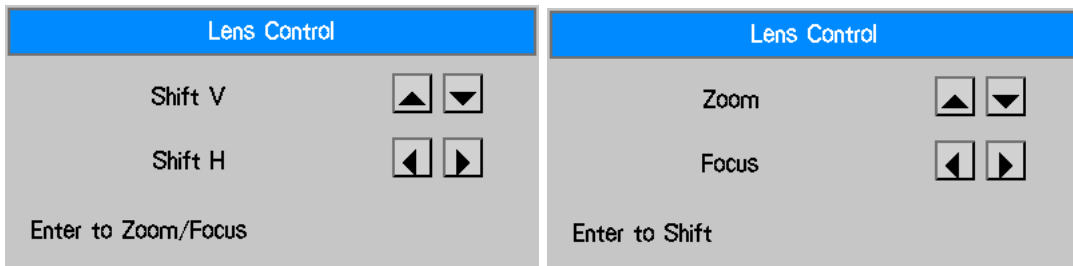

Test Pattern

The built-in test pattern is provided for installation and adjustment. You can select Test Pattern on OSD or the TEST PATTERN button on the remote control to display the test pattern menu, use ◀▶ or ▲▼ to select desired test pattern

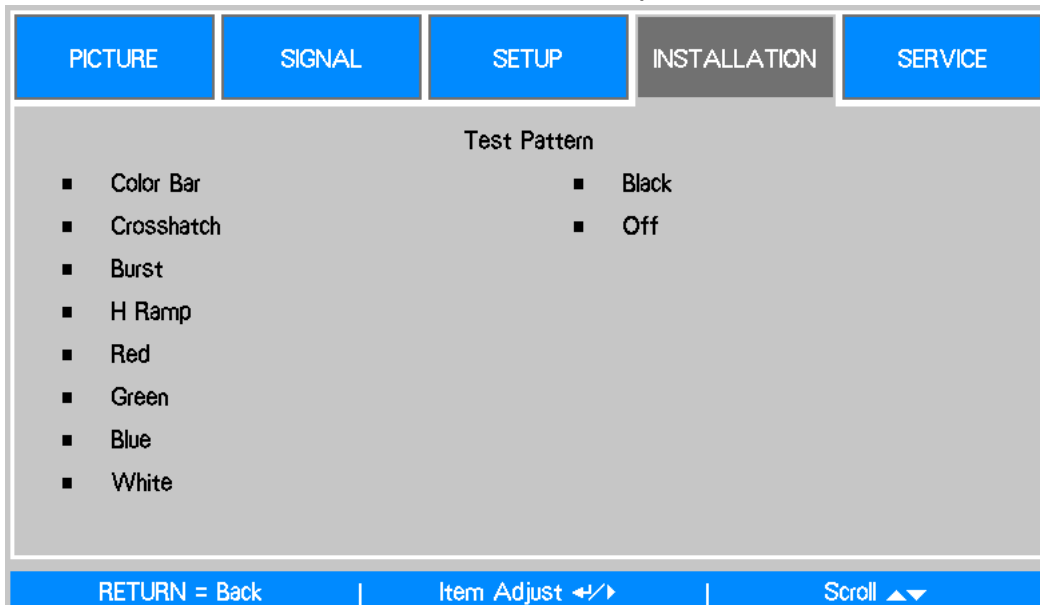

OSD Operation - SERVICE

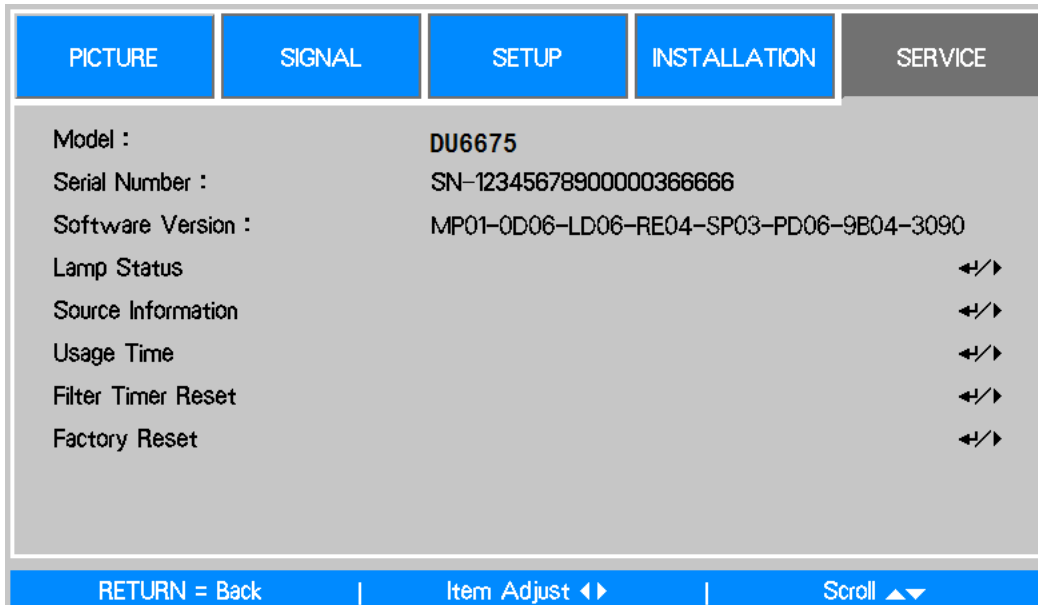

Model

Display the Projector model name.

Serial Number

Display the serial number of the projector.

Software Version

Display the software version of the projector.

Source Information

Display the current input source information.

Lamp Status

Display current lamp status of each lamp.

Usage Time

Display the current usage time, estimated remaining lamp life...etc.

Lamp1 Life Remaining: Display estimated remaining lamp1 life.

Lamp2 Life Remaining: Display estimated remaining lamp2 life.

Lamp1 Time: Display current lamp1 usage.

Lamp2 Time: Display current lamp2 usage.

Filter Time: Display the time from last reset of filter timer to now.

Power On Time: Display the total Power-On time of the projector.

Filter Timer Reset

Reset filter timer, please execute this function to synchronize the filter time display after cleaning or changing the filter.

Factory Reset

Use this function to restore the configuration of the menu to the factory default setting. All of the user setting options of the projector will be deleted and restored to the factory default settings.

Maintenance

Replacing the lamp

Depending on the lamp model, the lamp life is affected by the installation method and frequency of the lamp on/off operation. It is suggested to replace the projector lamp when the lamp is used for approximately 2500 hours to ensure high projection quality. In the OSD Menu, the lamp using time can be checked from the "OSD Menu - SERVICE". The lamp should be replaced when the projected image is obviously darkened. Contact your local dealer to purchase the authorized new lamp suitable for your projector.

Note:

- Purchase the lamp module produced by Vivitek. Using the lamp that is not made by Vivitek may affect the performance of the projector or damage the projector.

Lamp Handling Precautions:

- This projector uses a high-pressure lamp which must be handled carefully and properly. Improper handling may result in accidents, injury, or create a fire hazard.
- Lamp life may differ from lamp to lamp and according to the environment of use. There is no guarantee-tee of the same life for each lamp. Some lamps may fail or terminate their life in a shorter period of time than other similar lamps.
- If the projector indicates that the lamp should be replaced, i.e., if LAMP 1 and/or LAMP 2 light up, replace the lamp with a new one IMMEDIATELY after the projector has cooled down. (Follow carefully the instructions in the Lamp Replacement section of this manual.) Continuous use of the lamp with LAMP 1 and/or LAMP 2 lighted may increase the risk of lamp explosion.
- A Lamp may explode as a result of vibration, shock or degradation as a result of hours of use as its lifetime draws to an end. Risk of explosion may differ according to the environment or conditions in which the projector and lamp are being used.
- If a lamp explodes, the following safety precautions should be taken:
- Disconnect the projector's AC plug from the AC outlet immediately. Contact an authorized service station for a checkup of the unit and replacement of the lamp. Additionally, check carefully to ensure that there are no broken shards or pieces of glass around the projector or coming out from the cooling air circulation holes. Any broken shards found should be cleaned up carefully. No one should check the inside of the projector except those who are authorized trained technicians and who are familiar with projector service. Inappropriate attempts to service the unit by anyone, especially those who are not appropriately trained to do so, may result in an accident or injury caused by pieces of broken glass.
- The projection lamp should be replaced when it burns out. It should only be replaced with a certified replacement part, which you can order from your local dealer.

Warning:

- Be sure to turn off and unplug the projector at least 30 minutes before replacing the lamp. Failure to do so could result in a severe burn.
- Safety glasses should be worn when replacing the lamp while the projector is ceiling mounted

Replacing the Lamp

1. Remove the screw on the lamp cover (A), and lift the lamp cover as shown (B).
2. Loosen the two captive screws on the lamp module (A). Lift the module handle up as shown (B).
3. Pull firmly on the module handle in the direction shown to remove the lamp.
4. Install the new lamp module(s) and replace the lamp cover.
5. Tighten the two captive screws on the lamp module.
6. Place the lamp cover and tighten one screw on the cover as below illustration.

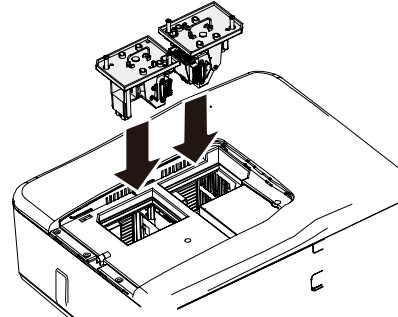
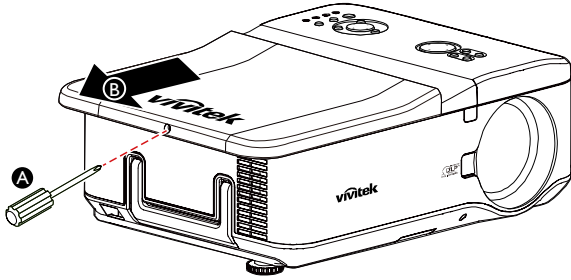

2. Loosen the two captive screws on the lamp module (A). Lift the module handle up as shown (B).

5. Tighten the two captive screws on the lamp module.

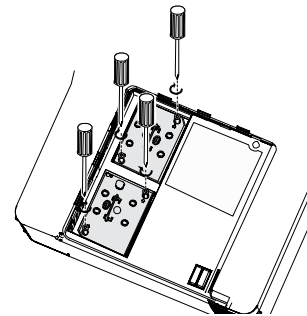
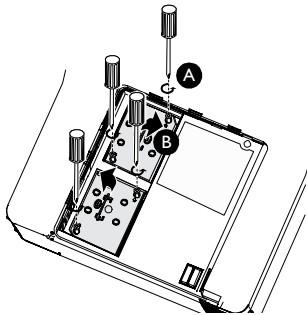

3. Pull firmly on the module handle in the direction shown to remove the lamp.

6. Place the lamp cover and tighten one screw on the cover as below illustration.

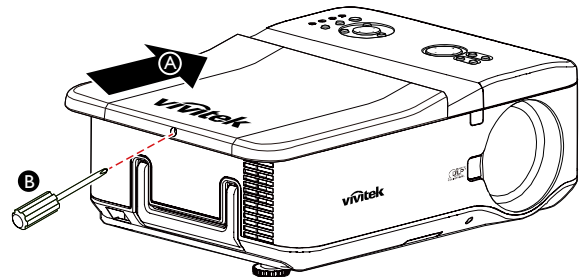
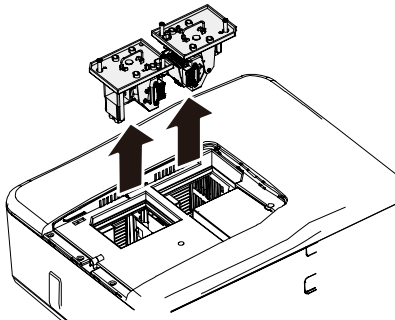

Cleaning the projector

Cleaning the Cabinet

Refer to the following guide to clean the projector cabinet.

1. Wipe off dust with a clean dampened cloth.
2. Moisten the cloth with warm water and mild detergent and wipe the cabinet.
3. Rinse all detergent from the cloth and wipe the projector again.

Caution:

- To prevent discoloration or fading of the case, do not use abrasive alcohol-based cleaners.

Cleaning the Lens

1. Apply a little optic lens cleaner to a clean, lint free cloth (do not apply the cleaner directly to the lens).
2. Lightly wipe the lens in a circular motion.

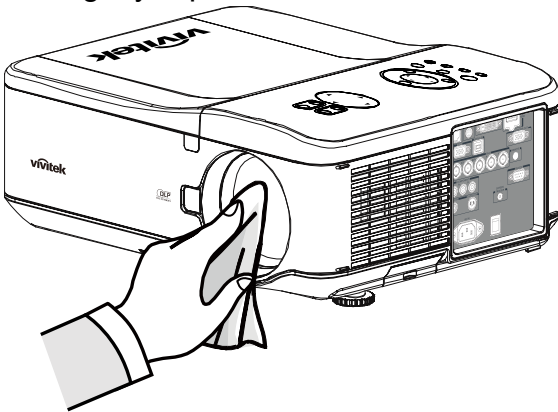
**Caution:**

- Do not use abrasive cleaners or solvents.
- To prevent discoloration or fading, avoid getting cleaner on the projector case.

Cleaning the Filters

The projector uses three filters to keep the fans free of dust and other particles, and should be cleaned every 500 hours of operation. In dusty environments, it is recommended to clean the filters more frequently. If the filter is dirty or clogged, your projector may overheat. When the message below is displayed, the filters must be cleaned.

Note:

- When the filter message is displayed, please clean all three filters at the same time to synchronize the Filter time display. The Filter Message item should be enabled in the Options menu.

Refer to the following guide to clean the filters.

1. The left and rear filters can be cleaned as demonstrated in the following images.

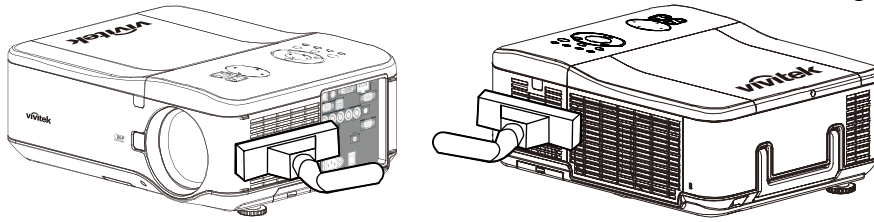

2. The rear exhaust vent can be accessed as shown.

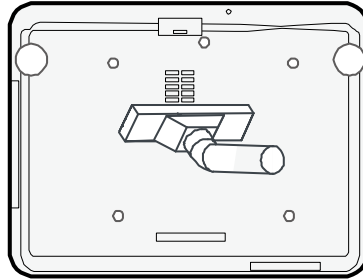

3. Gently slide the filter holders in the direction shown as below.

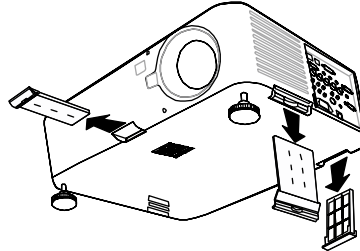

4. Lift the filter foams from all three filter holders in the direction shown. Remove them completely from each filter holder and discard.

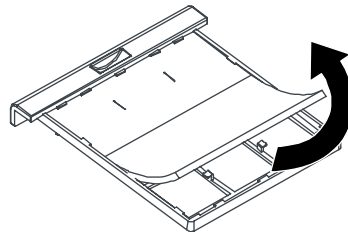

5. Place a replacement foam and press down firmly.

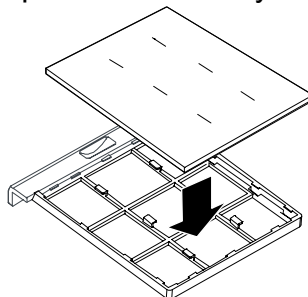

6. Replace the filter holders by pushing gently in the direction shown on below illustration.

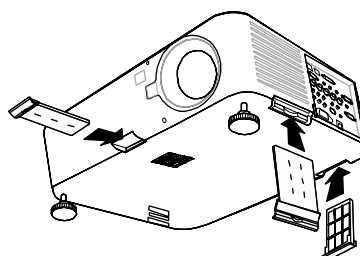

Specification

Model	DU6675
Display type	1-DLP 0.67" DMD
Native resolution	WUXGA (1920x1200)
Maximum resolution	WUXGA (1920x1200) @ 60Hz
Contrast	3000:1
Lamp life and type	2500/3500 hours (Normal / Eco mode), 280Wx2
Throw Ratio*	1.73-2.27:1
Image Size*	40~500"
Projection Distance*	1.83-14.9m (6-49ft)
Projection Lens*	F=1.64-1.86 f=26-34mm
Zoom Ratio*	1.3X
Aspect Ratio	16:10 Normal 4:3 compatible with 16:9
Lens Shift*	0%~+50% (V); +/-10% (H)
Keystone	V: +/-30°; H: +/-30°
Sync	V: 48-120Hz H: 15-90kHz
Video compatibility	SDTV (480i/576i), EDTV (480p/576p), HDTV (720p, 1080i/p)
I/O Port	HDMI v1.4a, DVI-D, 3D Sync Out, HDBase T / LAN (share with LAN control), RGB In, RGB Out, Component (YPbPr)/RGBHV, Component (RCA*3), Composite (RCA Jack), S-Video (Mini DIN 4pin), RS-232C, Screen Trigger, Wire (wired remote control), USB (for service).
Projection Method	Desktop projection, ceiling (front or rear)
Size (W x D x W)	505x194x385mm (excluding the protruding part)
Weight	16.5kg (excluding the lens)
Noise level	35dB/39dB (Dual Lamp Eco/Standard Mode)
POWER	AC100-240V, 50/60Hz
Power Consumption	< 0.5 watts for Off mode. (Power key/Remote power key only) < 6 watts for Network Standby mode. (LAN/RS232/Control Panel only)
Accessories	AC power cord, VGA cord, remote control, lens cap, user manual CD.

* Standard Lens

Product Dimensions

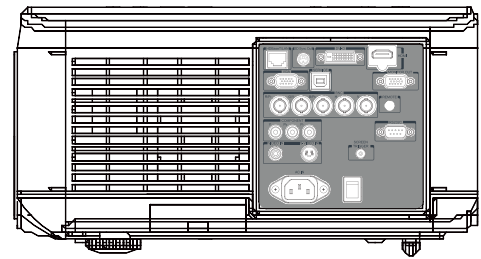
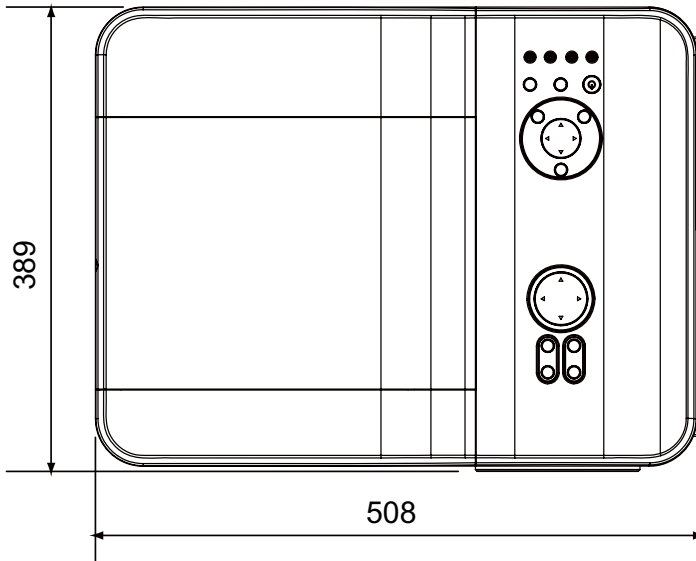
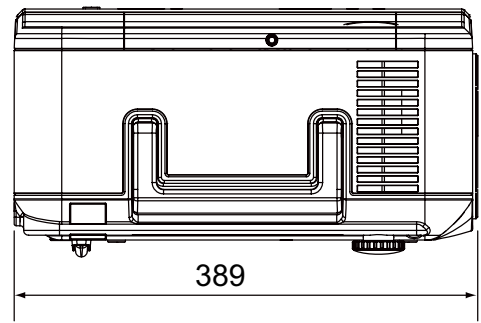
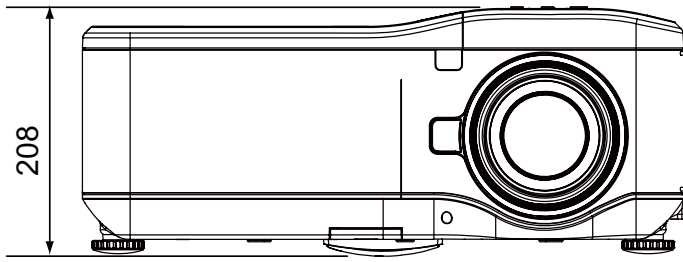

Supported Signal Input Timing

Signal type	Resolution	Frame rate	Component BNC		DVI-D	HDMI		HDBase T	3D support 3D format (frame sequential)	Video S-Video
			RGBHV	YUV		RGB	YUV			
PC	640*480-60	59.93	V	-	V	V	-	V	V	-
	640*480-75	75	V	-	V	V	-	V	-	-
	640*480-85	85.01	V	-	V	V	-	V	-	-
	800*600-60	60.32	V	-	V	V	-	V	V	-
	800*600-75	75	V	-	V	V	-	V	-	-
	800*600-85	85.06	V	-	V	V	-	V	-	-
	848*480-60	60	V	-	V	V	-	V	V	-
	1024*768-60	60	V	-	V	V	-	V	V	-
	1024*768-75	75.03	V	-	V	V	-	V	-	-
	1024-768-85	85.03	V	-	V	V	-	V	-	-
	1024-768-120	120	V	-	V	V	-	V	V	-
	1024-768RB-120	119.98	V	-	V	V	-	V	V	-
	1280*720-60	59.91	V	-	V	V	-	V	V	-
	1280*720-120	120	V	-	V	V	-	V	V	-
	1280*768-60	59.87	V	-	V	V	-	V	V	-
	1280*800-60	59.81	V	-	V	V	-	V	V	-
	1280*800RB-120	119.9	V	-	V	V	-	V	V	-
	1280*960-60	60	V	-	V	V	-	V	V	-
	1280*1024-60	60.02	V	-	V	V	-	V	V	-
	1280*1024-75	75.02	V	-	V	V	-	V	-	-
	1280*1024-85	85.02	V	-	V	V	-	V	-	-
	1440*900-60	59.887	V	-	V	V	-	V	V	-
	1400X1050-60	59.98	V	-	V	V	-	V	V	-
	1600*1200-60	60	V	-	V	V	-	V	V	-
1680*1050-59.94	59.94	V	-	V	V	-	V	V	-	
1920*1200RB-60	59.95	V	-	V	V	-	V	V	-	
Video	NTSC (M) (3.58, 4.43)	59.94	-	-	-	-	-	-	-	V
	PAL (B,G,H,I)	50	-	-	-	-	-	-	-	V
	PAL (N)	50	-	-	-	-	-	-	-	V
	PAL (M)	60	-	-	-	-	-	-	-	V
	S E C A M (M) (4.25/4.4)	50	-	-	-	-	-	-	-	V
SDTV	1440x480i	60	-	-	-	V	V	V (HDMI)	-	-
	1440x576i	50	-	-	-	V	V	V (HDMI)	-	-
	480i	59.94	-	V	-	-	-	-	-	V
	576i	50	-	V	-	-	-	-	-	V
EDTV	480p	59.94	V	V	V	V	V	V	-	-
	576p	50	V	V	V	V	V	V	-	-
	1080i	50	-	V	V	V	V	V	-	-
	1080i	60	-	V	V	V	V	V	-	-
	720p	50	V	V	V	V	V	V	V	-
	720p	60	V	V	V	V	V	V	V	-
	1080p	24	V	V	V	V	V	V	-	-
	1080p	25	V	V	V	V	V	V	-	-
	1080p	29.97	V	V	V	V	V	V	-	-
	1080p	30	V	V	V	V	V	V	-	-
	1080p	50	V	V	V	V	V	V	V	-
	1080p	60	V	V	V	V	V	V	V	-

Configurations of Terminals

DVI-D

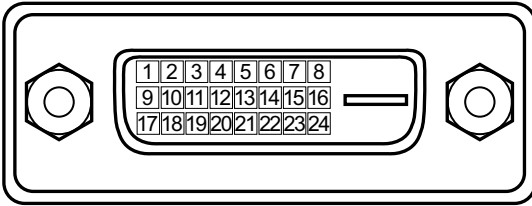

1	T.M.D.S. Data 2- Input	13	N.C
2	T.M.D.S. Data 2+ Input	14	P5V
3	Ground	15	Ground
4	N.C	16	HPD
5	N.C	17	T.M.D.S. Data 0- Input
6	SCL	18	T.M.D.S. Data 0+ Input
7	SDA	19	Ground
8	N.C	20	N.C
9	T.M.D.S. Data 1- Input	21	N.C
10	T.M.D.S. Data 1+ Input	22	Ground
11	Ground	23	T.M.D.S. Clock+ Input
12	N.C	24	T.M.D.S. Clock- Input

VGA (D-sub 15 pin)

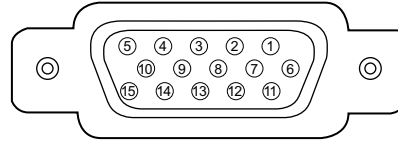

Input

1	Red Input	9	P5V
2	Green Input	10	GND
3	Blue Input	11	GND
4	N.C	12	VGA_SDA
5	N.C	13	H-Sync
6	GND	14	V-Sync
7	GND	15	VGA_SCL
8	GND	16	GND

HDMI(19 pin Type A)

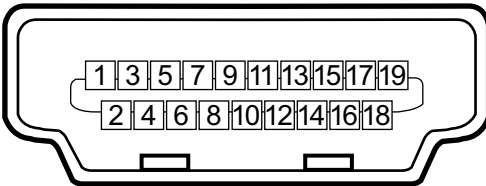

1	T.M.D.S. Data 2+ Input	11	Ground
2	Ground	12	T.M.D.S. Clock C- Input
3	T.M.D.S. Data 2- Input	13	CEC
4	T.M.D.S. Data 1+ Input	14	N.C
5	Ground	15	SCL
6	T.M.D.S. Data 1- Input	16	SDA
7	T.M.D.S. Data 0+ Input	17	Ground
8	Ground	18	P5V
9	T.M.D.S. Data 0- Input	19	HPD
10	T.M.D.S. Clock C+ Input		

Serial Control (RS-232, D-sub 9 pin)

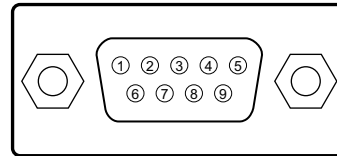

Serial	
1	N.C
2	RXD
3	TXD
4	N.C
5	Ground
6	N.C
7	Short with pin8
8	Short with pin7
9	N.C

3D Sync Out

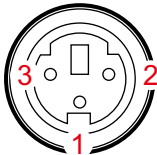

1	Signal
2	Ground
3	VCC(5V)

Service (USB Type A)

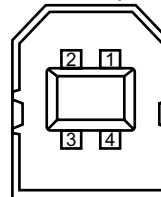

Screen Trigger

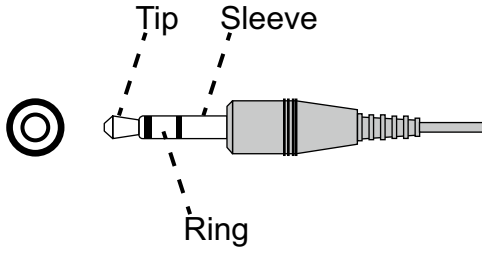

1	Tip	VCC(12V)
2	Sleeve-	Ground
3	Ring	Signal

Wired Remote

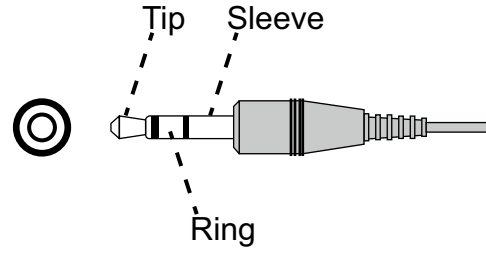

1	Tip	VCC(3.3V)
2	Sleeve-	Ground
3	Ring	Signal

HDBaseT/LAN Terminal (RJ-45)

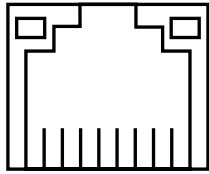

8 7 6 5 4 3 2 1

1	TX+
2	TX-
3	TXC
4	Ground
5	Ground
6	RXC
7	RX+
8	RX-

DU6675 Lens Series

7 types of optional powered lenses are available for the projector. Contact the authorized dealer of Vivitek for details.

Part Number	Lens Name	F Number	Focal Length	Zoom Ratio	Screen Size	Throw Ratio
D88-UWZ01	Ultra Wide Zoom	1.96-2.3	11.3-14.1mm	1.25:1	40"-500"	0.75-0.93:1
D88-WF18501	Wide Fix	1.85	11.6mm	---	40"-500"	0.76:1
D88-WZ01	Wide Zoom	1.85-2.5	18.7-26.5mm	1.41:1	40"-500"	1.25-1.79:1
D88-ST001	Standard Lens	1.7-1.9	26-34mm	1.3:1	40"-500"	1.73-2.27:1
D88-SMLZ01	Semi Long Zoom	1.86-2.48	32.9-54.2mm	1.65:1	40"-500"	2.22-3.67:1
D88-LOZ101	Long Zoom 1	1.85-2.41	52.8-79.1mm	1.5:1	40"-500"	3.58-5.38-1
D88-LOZ201	Long Zoom 2	1.85-2.48	78.5-121.9mm	1.55:1	40"-500"	5.31-8.26:1

- Above lenses can support to vertical shift 0-50%, horizontal shift $\pm 10\%$ except of D88-WF18501.
- D88-WF18501 is a fixed lens, the vertical and horizontal shift range is 0%, the corners of the projected image may appear shadows or distortion if lens is shifted horizontally or vertically.

Troubleshooting

Indicator Messages

Several indicator messages are used to display the current projector status or alert the abnormal message. The LEDs on the top surface of the projector show the status of the POWER, WARNING LAMP 1 and LAMP 2

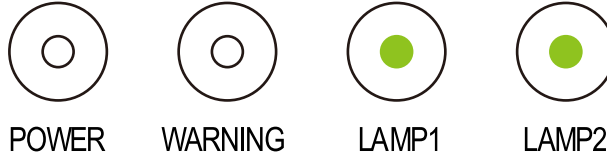

Below tables describe the various states of the 4 LEDs.

LED INDICATOR STATUS		PROJECTOR STATUS	
Power	Off	AC off	
	Red on	Standby	
	Green on	Power on	
	Orange blinks	Projector is under cooling	
	Green blinks	Start up	
Warning	Off	Normal condition	
	Red blinks 1 time	The lamp cover is open.	Check if lamp cover is installed properly.
	Red blinks 2 times	The internal temperature is abnormally high.	<ul style="list-style-type: none"> The temperature around the projector are high, use the projector in an environment with the temperature of lower than 104°F (40°C). Air intake may be blocked, relocate the projector to an area with proper ventilation. Internal circuit may be fail, contact the local Vivitek service center.
Lamp 1 Lamp 2	Off	Lamp is turned off.	
	Green on	Lamp mode is set to Normal.	
	Orange on	Lamp mode is set to ECO.	
	Green blinks	Lamp model is set to Normal, it's warming up or under cooling.	
	Orange blinks	Lamp model is set to Eco, it's warming up or under cooling.	<ul style="list-style-type: none"> No lamp is installed or lamp should be replaced, check if the lamp is installed properly. The lamp is burnt out. Contact with your nearest authorized dealer or service center.
	Red blinks	The lamp does not illuminate.	

Common Problems and Solutions

These guidelines provide tips to deal with problems you may encounter while using the projector. If the problem remains unsolved, contact your dealer for assistance.

Often the problem is something as simple as a loose connection. Check the following before proceeding to the problem-specific solutions.

- Use some other electrical device to confirm that the electrical outlet is working.
- Ensure the projector is turned on.
- Ensure all connections are securely attached.
- Ensure the attached device is turned on.
- Ensure a connected PC is not in suspend mode.
- Ensure a connected notebook computer is configured for an external display. (This is usually done by pressing an Fn-key combination on the notebook.)

Tips for Troubleshooting

- In each problem-specific section, try the steps in the order suggested. This may help you to solve the problem more quickly.
- Try to pinpoint the problem to avoid replacing non-defective parts.
- For example, if you replace batteries and the problem remains, put the original batteries back and go to the next step.
- Keep a record of the steps you take when troubleshooting: The information may be useful when call-ing for technical support or for passing on to service personnel.

Image Problems

Problem: No image appears on the screen

1. Verify the settings on your notebook or desktop PC.
2. Turn off all equipment and power up again in the correct order.

Problem: The image is blurred

1. Adjust the Focus on the projector.
2. Press the AUTO button on the remote control or projector.
3. Ensure the projector-to-screen distance is within the specified range.
4. Check that the projector lens is clean.
5. Remove the lens cover.

Problem: The image is wider at the top or bottom (trapezoid effect)

1. Position the projector so it is as perpendicular to the screen as possible.
2. Use the Keystone function to correct the problem

Problem: The image is reversed or upside down

Check the Projection Mode setting on the INSTALLATION menu.

Problem: The image is streaked

1. Set the Total dots (H Total) and VGA Setup settings on the SIGNAL menu of the OSD to the default settings.
2. To ensure the problem is not caused by a connected PC's video card, connect to another computer.

Problem: The image is flat with no contrast

1. Adjust the Contrast setting on the PICTURE menu of the OSD.
2. Adjust the Brightness setting on the PICTURE menu of the OSD.

Problem: The color of the projected image does not match the source image.

Adjust the Color temperature and Gamma settings on the PICTURE menu of the OSD.

Lamp Problems**Problem: There is no light from the projector.**

1. Check that the power cable is securely connected.
2. Ensure the power source is good by testing with another electrical device.
3. Restart the projector in the correct order and check that the Power LED is green.
4. If you have replaced the lamp recently, check the lamp installation and try resetting the lamp connections.
5. Replace the lamp module.
6. Put the old lamp back in the projector and have the projector serviced if the problem can not be fixed.

Problem: The lamp goes off

1. Check if both lamps are installed, projector will enter to protection mode if one of lamp is not installed.
2. Press the power button twice to turn off the projector and turn off AC Power, restart the projector again. It's possible that power surges can cause the lamp to turn off.
3. Replace the lamp module.

Remote Control Problems**Problem: The projector does not respond to the remote control.**

1. Direct the remote control towards remote sensor on the projector.
2. Ensure the path between remote and sensor is not obstructed.
3. Turn off any fluorescent lights in the room.
4. Check the battery polarity.
5. Replace the batteries.
6. Turn off other Infrared-enabled devices in the vicinity.
7. Have the remote control serviced.
8. Ensure that the remote control code conforms to the projector's code if universal remote control is used.
9. Ensure Front or Back remote sensor is turned on (SETUP/Advanced/Remote Sensor).

Projection Lens Problems**Problem: The Zoom or Focus adjustment can not work.**

1. Check if the lens is installed problem, improper lens installation may cause to lens can not work normally. Please follow the lens installation procedure to check again.
2. Relace the other lens to check the problem if the lens is available.
3. Contact with service center for the details.

Having the Projector Serviced

If you are unable to solve the problem, you should have the projector serviced. Pack the projector in the original carton. Include a description of the problem and a checklist of the steps you took when trying to fix the problem. The information may be useful to the service personnel. Return the projector to the place you purchased it.

About the Vivitek Support

If you cannot find solutions from this user guideline, please contact us using the contact information below.

North America

Vivitek Service Center
15700 Don Julian Road, Suite B
City of Industry, CA. 91745
U.S.A

Tel: 855-885-2378 (Toll-Free)
Email: T.services1@vivitekcorp.com
URL: www.vivitekusa.com

Europe, Middle East and Africa

Vivitek Service & Support
Zandsteen 15
2132 MZ Hoofddorp
The Netherlands

Tel: +31 20 655 0960
Email: support@vivitek.eu
URL: www.vivitek.eu

China

Vivitek Service Center
上海浦东世纪大道 1090 号斯米克大厦 18 层 1802 室, 201209

Tel: 400-888-3526 (Toll-Free)
Tel: 021-58360088-142 (Direct)
Email: service@vivitek.com.cn
URL: www.vivitek.com.cn

Asia and Taiwan

VIVITEK after-sales service
Vivitek Corporation, Co., Ltd.
4F., No.186, Ruiguang Rd., Neihu Dist., Taipei City 11491

TEL: 86-28-797-2088
FAX: 86-26-600-2358
E-mail: kenny.chang@vivitek.com.tw
URL: www.vivitek.com.tw